

—
KRONOTERM 1976
TOPLLOTNE ČRPALKE



—
**DODATNA
OPREMA**

—
ADAPT
toplotna črpalka

98-22-49-14722-00 – Dodatna oprema - ADAPT

Tiskano v Sloveniji, avtorske pravice so last Kronoterm d.o.o.

To delo je avtorsko zaščiteno. Vsaka uporaba izven meja zakona o avtorskih pravicah brez soglasja Kronoterm d.o.o. je nezakonita in kazniva po zakonu. Pridržujemo si pravico do sprememb.

Kljub temu da je bilo zagotavljanju točnosti vseh slik in opisov namenjeno veliko pozornosti, si Kronoterm d.o.o. pridržuje pravico do popravka napak ter do spremembe tehničnih podatkov in slik brez predhodne najave. Podatki so podani na osnovi najnovejših informacij o proizvodu, ki so bile na voljo v času priprave in tiskanja produktne lista. Pridržana je pravica do ukinitve prodaje posameznega produkta ali celotnega prodajnega programa.

Slike so simbolične in služijo zgolj kot ponazoritev. Kljub našemu trudu ne moremo zagotavljati, da bodo v tiskovinah ali v elektronskem prikazu barve, razmerja ali drugi grafični elementi prikazani pravilno. Proizvodi se lahko razlikujejo od slikovne podobe. Za kakršna koli vprašanja nam pišite na info@kronoterm.com.

KAZALO

TOPLOTNA ČRPALKA ADAPT	4
HIDRAVLIČNE NOTRANJE ENOTE, HRANILNIKI TOPLE SANITARNE VODE, ZALOGOVNIKI IN PRIPADAJOČA DODATNA OPREMA	7
RAZŠIRITVENI MODULI IN PRIPADAJOČA DODATNA OPREMA.....	14
OPREMA ZA OGREVALNI SISTEM	19
OPREMA ZA MONTAŽO IN SERVIS.....	24

TOPLOTNA ČRPALKA ADAPT

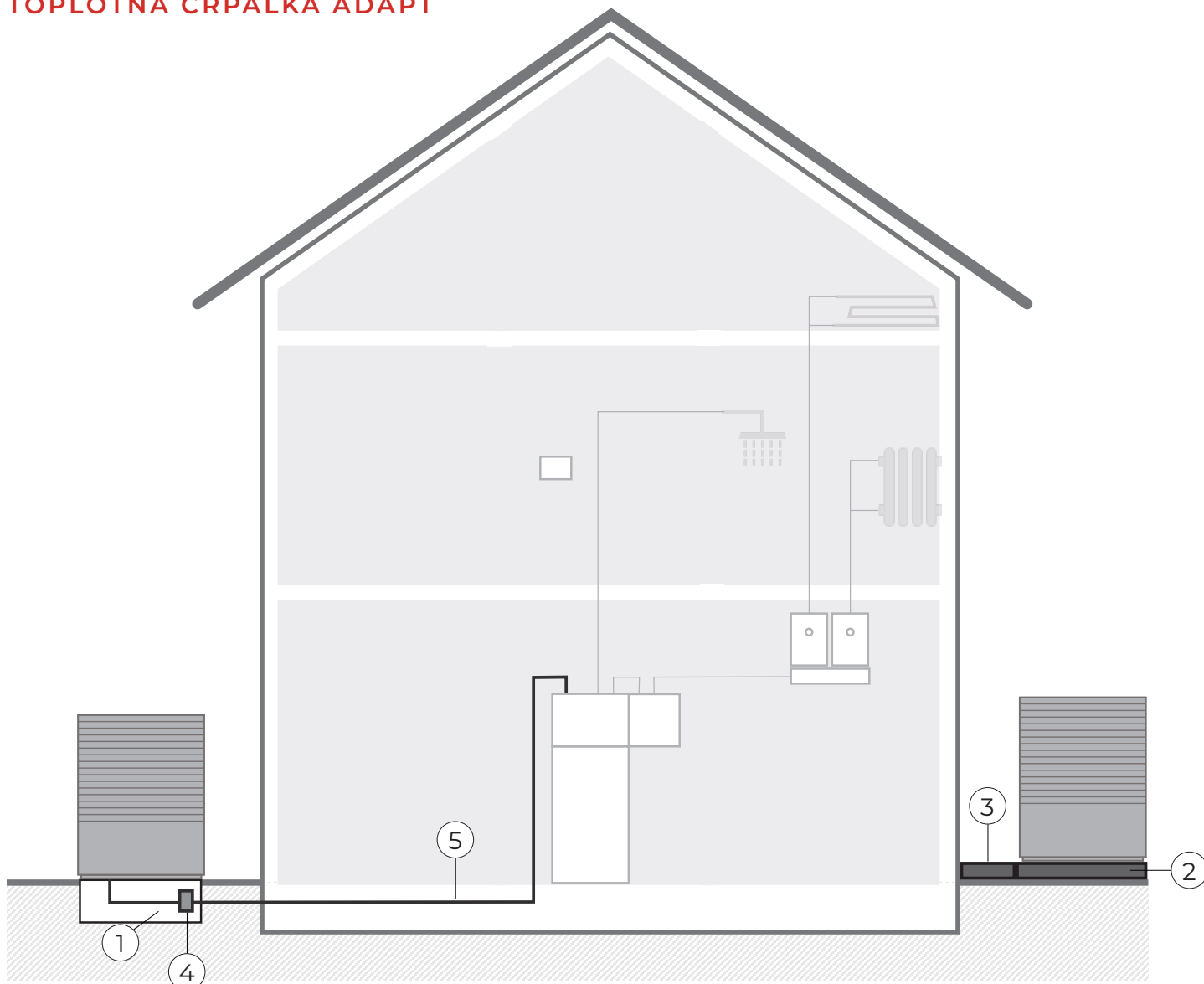

Opis Zemeljski betonski temelj za ADAPT

Naziv ZBT_ADAPT

Ident 2222000106812

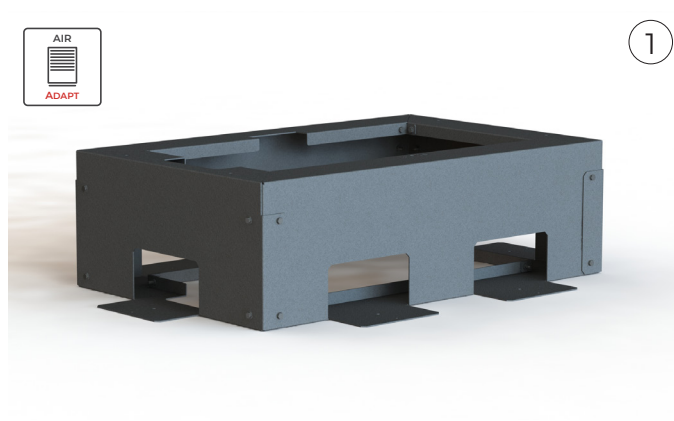

Opis Zemeljski kovinski temelj za ADAPT

Naziv ZKT_ADAPT

Ident 2222000106805

TOPLITNA ČRPALKA ADAPT



Opis Talni kovinski temelj za ADAPT

Naziv TKT_ADAPT

Ident 2222000106799



Opis Pokrov povezovalnih talnih cevi, kotni, za ADAPT

Naziv PCT_K

Ident 2222000110741



Opis Pokrov povezovalnih talnih cevi, ravni, za ADAPT

Naziv PCT_350-700

Ident 2222000110192



Opis Varnostni izpustni ventil, G 1" ZN

Naziv VIV_108601

Ident 2222000116453



Opis Varnostni izpustni ventil, G 5/4" ZN

Naziv VIV_108701

Ident 2222000116965

TOPLITNA ČRPALKA ADAPT



5



Opis Predizolirana cev za toplotno črpalko, fi 140

Naziv CE_P 2x32/140 Q

Ident 2222000136376



5



Opis Spojka za predizolirano cev, priključek G 1" ZN, medenina

Naziv SP_P 32x2,9 G1

Ident 2222000136444



5



Opis Zaključna kapa za predizolirano cev, vsebuje zaključno kapo, nerjaveč objemni obroč in tesnilni obroč

Naziv ZK_P 140 Q

Ident 2222000136451

HIDRAVLIČNE ENOTE, HRANILNIKI TOPLE SANITARNE VODE, ZALOGOVNIKI IN PRIPADAJOČA DODATNA OPREMA

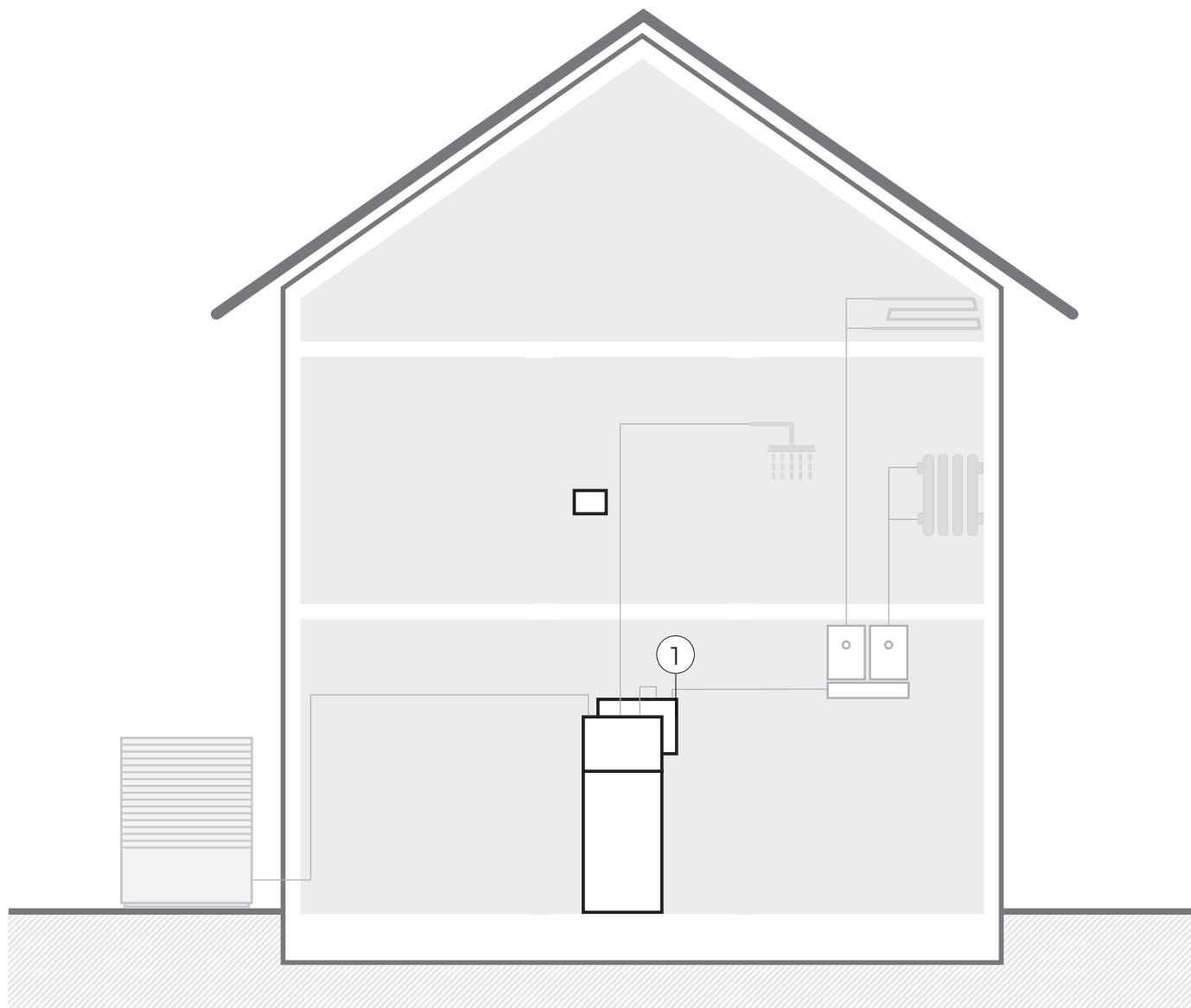

Opis Kompaktna hidravlična enota za ADAPT

Naziv HYDRO C2

Ident 2222000115722



Opis Zalogovnik ogrevalne vode z izolacijo za HYDRO C2, 40 [l] zalogovnik

Naziv ZA_P 40

Ident 2222000116163

HIDRAVLIČNE ENOTE, HRANILNIKI TOPLE SANITARNE VODE, ZALOGOVNIKI IN PRIPADAJOČA DODATNA OPREMA



Opis Osnovna stenska hidravlična enota za ADAPT

Naziv HYDRO S2

Ident 2222000121341



Opis Zalogovnik ogrevalne vode za HYDRO S2, 40 [l] zalogovnik

Naziv HYDRO P2

Ident 2222000121549



Opis Stenski nosilec in distančnik za HYDRO S2

Naziv HYDRO A2

Ident 2222000121556

HIDRAVLIČNE ENOTE, HRANILNIKI TOPLE SANITARNE VODE, ZALOGOVNIKI IN PRIPADAJOČA DODATNA OPREMA

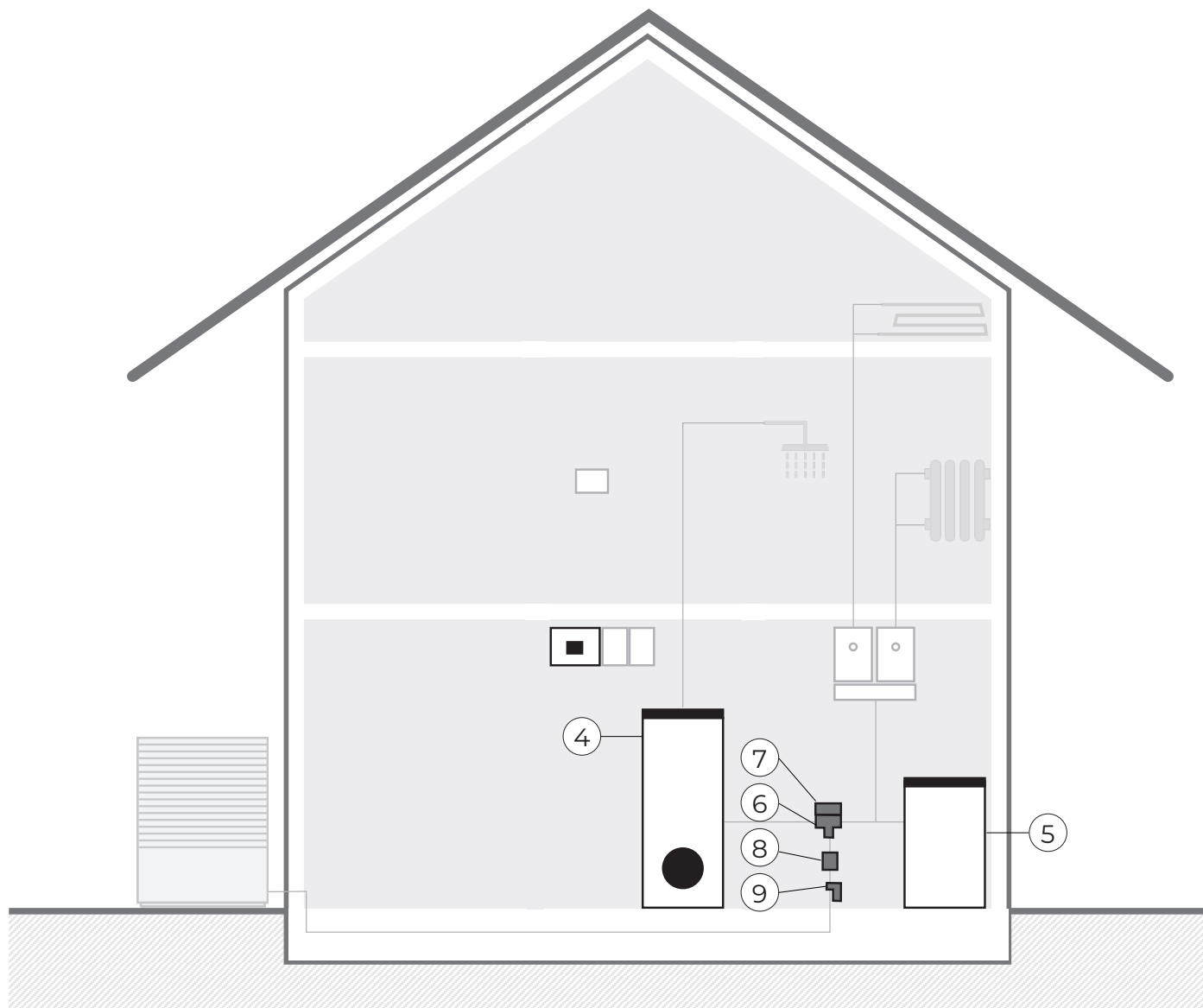

Opis Stenska regulacijska enota KSM 2

Naziv WR KSM 2

Ident 2222000125745



5

Opis Zalogovnik ogrevalne vode z izolacijo in plaščem, 100 [l]

Naziv ZA_PS 100

Ident 2222000008000

HIDRAVLIČNE ENOTE, HRANILNIKI TOPLE SANITARNE VODE, ZALOGOVNIKI IN PRIPADAJOČA DODATNA OPREMA



Opis Hranilnik tople sanitarne vode za toplotne črpalke, 160 [l]

Naziv BO_HR 160

Ident 2222000025144

Opis Plašč za hranilnik tople sanitarne vode HR-160

Naziv PL_HR 160

Ident 2222000031169



Opis Hranilnik tople sanitarne vode za toplotne črpalke, 200 [l]

Naziv BO_HR 200

Ident 2222000025175

Opis Plašč za hranilnik tople sanitarne vode HR-200, bele barve

Naziv PL_HR 200 W

Ident 2222000125523

Opis Plašč za hranilnik tople sanitarne vode HR-200

Naziv PL_HR 200

Ident 2222000021955



Opis Hranilnik tople sanitarne vode za toplotne črpalke, 300 [l]

Naziv BO_HR 300

Ident 2222000002848

Opis Plašč za hranilnik tople sanitarne vode HR-300

Naziv PL_HR 300

Ident 2222000006525

HIDRAVLIČNE ENOTE, HRANILNIKI TOPLE SANITARNE VODE, ZALOGOVNIKI IN PRIPADAJOČA DODATNA OPREMA



5

Opis Zalogovnik ogrevalne vode z izolacijo in plaščem

Naziv ZA_WPPS 200

Ident 2222000015213



5

Opis Zalogovnik ogrevalne vode z izolacijo in plaščem

Naziv ZA_WPPS 300

Ident 2222000015206



4

Opis Hranilnik tople sanitarne vode za toplotne črpalke, 300 [l]

Naziv BO_WPS 304 TT

Ident 2222000050313



5

Opis Zalogovnik ogrevalne vode z izolacijo in plaščem, 150 [l]

Naziv ZA_PS 150 TT

Ident 2222000051013



Opis Set zalogovnika ogrevalne vode in hranilnika tople sanitarne vode za toplotne črpalke

Naziv BZ_WPS 150/304 TT

Ident 2222000074296

HIDRAVLIČNE ENOTE, HRANILNIKI TOPLE SANITARNE VODE, ZALOGOVNIKI IN PRIPADAJOČA DODATNA OPREMA



Opis 3-potni preklopni ventil, G 5/4" ZN

Naziv TVE_EMV 3P 525-32

Ident 2222000060718



Opis Elektro-motorni pogon za 3-potni preklopni ventil

Naziv EMP_EMV 110-K

Ident 2222000034580



Opis Pretočno električno grelo, G 5/4" ZN, napajanje 3 x 230 [V], moč 6 [kW]

Naziv PG_6

Ident 2222000116521



Opis Pretočno električno grelo, G 6/4" NN, napajanje 3 x 230 [V], moč 12 [kW]

Naziv PG_12

Ident 2222000116538



Opis Magnetni ločevalnik nečistoč, spojka 28 [mm]

Naziv MLN_UE028WJ

Ident 2222000068806



Opis Magnetni ločevalnik nečistoč, G 1" NN

Naziv MLN_UE100WJ

Ident 2222000096717

HIDRAVLIČNE ENOTE, HRANILNIKI TOPLE SANITARNE VODE, ZALOGOVNIKI IN PRIPADAJOČA DODATNA OPREMA



Opis Magnetni ločevalnik nečistoč, R 5/4" NN,
nominalni pretok 3,6 [m³/h]

Naziv MLN_UE125WJ

Ident 2222000096700

RAZŠIRITVENI MODULI IN PRIPADAJOČA DODATNA OPREMA

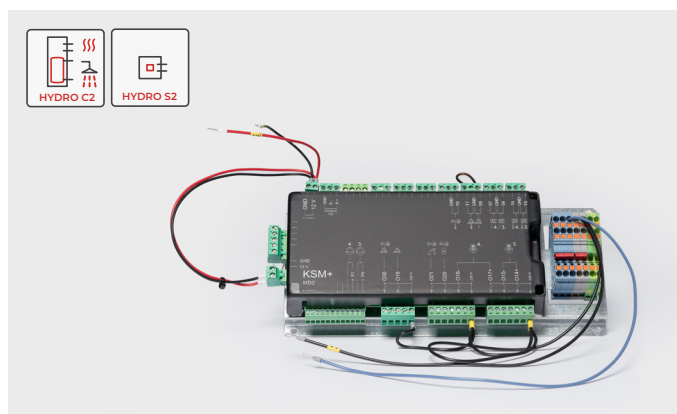

Opis Razširitveni modul za KSM - HYDRO C2/S2

Naziv KSM+ 2

Ident 2222000122492

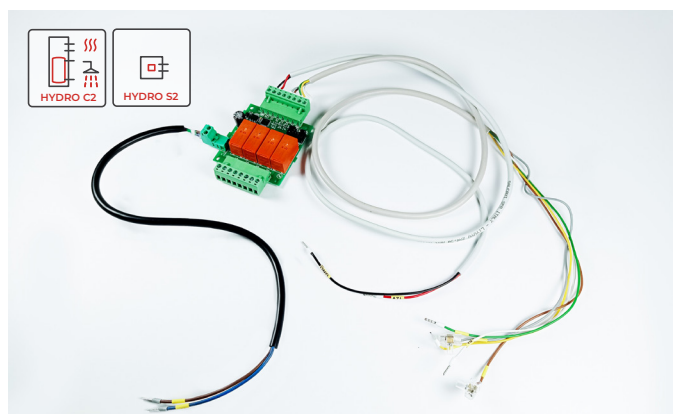

Opis Relejni modul za HYDRO C2/S2 ter obtočne črpalke

Naziv HYDRO PWM-R

Ident 2222000107130

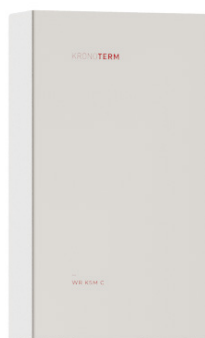

Opis Stenska regulacijska enota KSM, razširitveni modul

Naziv WR KSM+

Ident 2222000112684

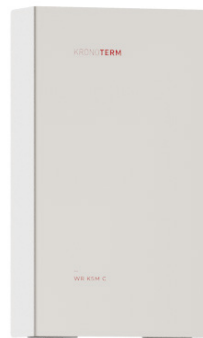

Opis Stenska regulacijska enota KSM za povezavo toplotne črpalke v kaskado

Naziv WR KSM C

Ident 2222000112691

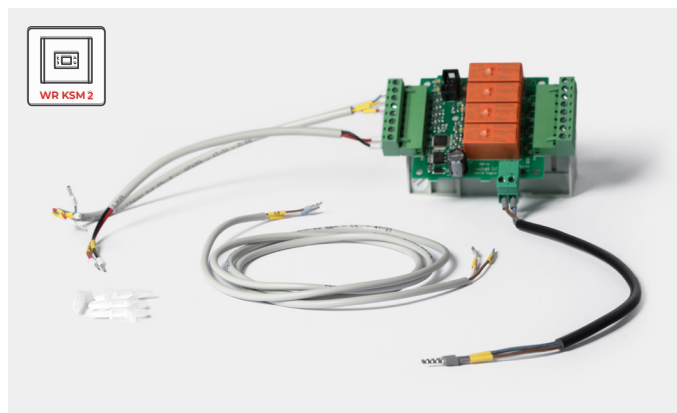

Opis Relejni modul za WR KSM 2 ter obtočne črpalke

Naziv WR PWM-R

Ident 2222000118174

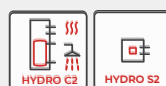

Opis Polnilni set za HYDRO C2/S2; obvezna dodatna oprema je KIT_PP WR KSM 2

Naziv SET_PO HYDRO

Ident 2222000122676

RAZŠIRITVENI MODULI IN PRIPADAJOČA DODATNA OPREMA



Opis Kit tlačnega tipala za WR KSM 2, napetostno tipalo

Naziv KIT_PP WR KSM 2

Ident 2222000129194

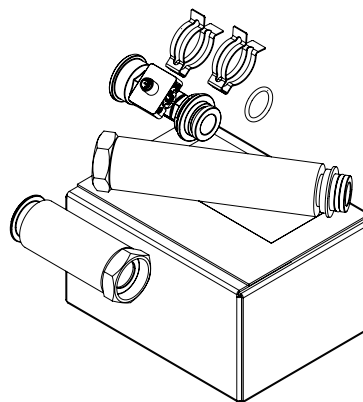

Opis Kit pretočnega tipala za WR KSM 2, napetostno tipalo

Naziv KIT_FP WR KSM 2

Ident 2222000129187



Opis Kit tipal za kaskadno rešitev ADAPT-O/-X

Naziv KIT_TT 1000

Ident 2222000129590

RAZŠIRITVENI MODULI IN PRIPADAJOČA DODATNA OPREMA



Opis Elektro omara za ADAPT 0312, 1 F, C16 C20, 2 [kW]

Naziv EO_S 1F 2kW

Ident 2222000114343

Opis Elektro omara za ADAPT 0312, 1 F, C20 C20, 4 [kW]

Naziv EO_S 1F 4kW

Ident 2222000114367

Opis Elektro omara za ADAPT 0312 ali ADAPT 0416, 3 F, C16 C10, 6 [kW]

Naziv EO_S/M 3F 6kW

Ident 2222000114404



Opis Elektro omara za ADAPT 0416, 1 F, C16 C25, 2 [kW]

Naziv EO_M 1F 2kW

Ident 2222000114350

Opis Elektro omara za ADAPT 0416, 1 F, C20 C25, 4 [kW]

Naziv EO_M 1F 4kW

Ident 2222000114374

Opis Elektro omara za ADAPT 0724, 3 F, C16 C20, 6 [kW]

Naziv EO_L 3F 6kW

Ident 2222000114411

RAZŠIRITVENI MODULI IN PRIPADAJOČA DODATNA OPREMA



Opis Merilnik električne energije, 1 F, WM1-6, naprodaj samo skupaj z elektro omaro

Naziv EO_WM1-6

Ident 2222000114428



Opis Merilnik električne energije, 3 F, WM3-6, naprodaj samo skupaj z elektro omaro

Naziv EO_WM3-6

Ident 2222000114435



Opis Adapter WiFi-Ethernet, RJ45

Naziv WM_WIFI EXT

Ident 2222000044688



Opis Komunikacijski kabel med notranjo in zunanjo enoto, 7 [m], FTP 8 x 0,20 [mm²]

Naziv KK_7M 8x0,20 FTP

Ident 2222000110246

Opis Komunikacijski kabel med notranjo in zunanjo enoto, 15 [m], FTP 8 x 0,20 [mm²]

Naziv KK_15M 8x0,20 FTP

Ident 2222000110253

Opis Komunikacijski kabel med notranjo in zunanjo enoto, 25 [m], FTP 8 x 0,20 [mm²]

Naziv KK_25M 8x0,20 FTP

Ident 2222000110260

RAZŠIRITVENI MODULI IN PRIPADAJOČA DODATNA OPREMA



Opis Napajalni kabel ADAPT ali notranje enote HYDRO, 7 [m] 5 x 2,5 [mm²]

Naziv NK_7M 5x2,5 H05VV-F

Ident 2222000110277

Opis Napajalni kabel ADAPT ali notranje enote HYDRO, 15 [m] 5 x 2,5 [mm²]

Naziv NK_15M 5x2,5 H05VV-F

Ident 2222000110284

Opis Napajalni kabel ADAPT ali notranje enote HYDRO, 25 [m] 5 x 2,5 [mm²]

Naziv NK_25M 5x2,5 H05VV-F

Ident 2222000110291

Opis Napajalni kabel ADAPT ali notranje enote HYDRO, 7 [m], 3 x 2,5 [mm²]

Naziv NK_7M 3x2,5 H05VV-F

Ident 2222000110307

Opis Napajalni kabel ADAPT ali notranje enote HYDRO, 15 [m], 3 x 2,5 [mm²]

Naziv NK_15M 3x2,5 H05VV-F

Ident 2222000110314

Opis Napajalni kabel ADAPT ali notranje enote HYDRO, 25 [m], 3 x 2,5 [mm²]

Naziv NK_25M 3x2,5 H05VV-F

Ident 2222000110321



Opis Napajalni kabel zunanje enote ADAPT ali notranje enote HYDRO, 7 [m], 5 x 4,0 [mm²]

Naziv NK_7M 5x4,0 H05VV-F

Ident 2222000110338

Opis Napajalni kabel zunanje enote ADAPT ali notranje enote HYDRO, 15 [m], 5 x 4,0 [mm²]

Naziv NK_15M 5x4,0 H05VV-F

Ident 2222000110345

Opis Napajalni kabel zunanje enote ADAPT ali notranje enote HYDRO, 25 [m], 5 x 4,0 [mm²]

Naziv NK_25M 5x4,0 H05VV-F

Ident 2222000110352

Opis Napajalni kabel zunanje enote ADAPT ali notranje enote HYDRO, 7 [m], 3 x 4,0 [mm²]

Naziv NK_7M 3x4,0 H05VV-F

Ident 2222000110369

Opis Napajalni kabel zunanje enote ADAPT ali notranje enote HYDRO, 15 [m], 3 x 4,0 [mm²]

Naziv NK_15M 3x 4,0 H05VV-F

Ident 2222000110376

Opis Napajalni kabel zunanje enote ADAPT ali notranje enote HYDRO, 25 [m], 3 x 4,0 [mm²]

Naziv NK_25M 3x4,0 H05VV-F

Ident 2222000110383

OPREMA ZA OGREVALNI SISTEM

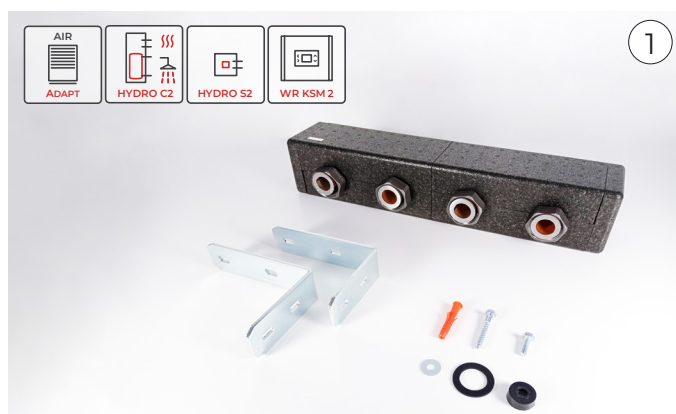
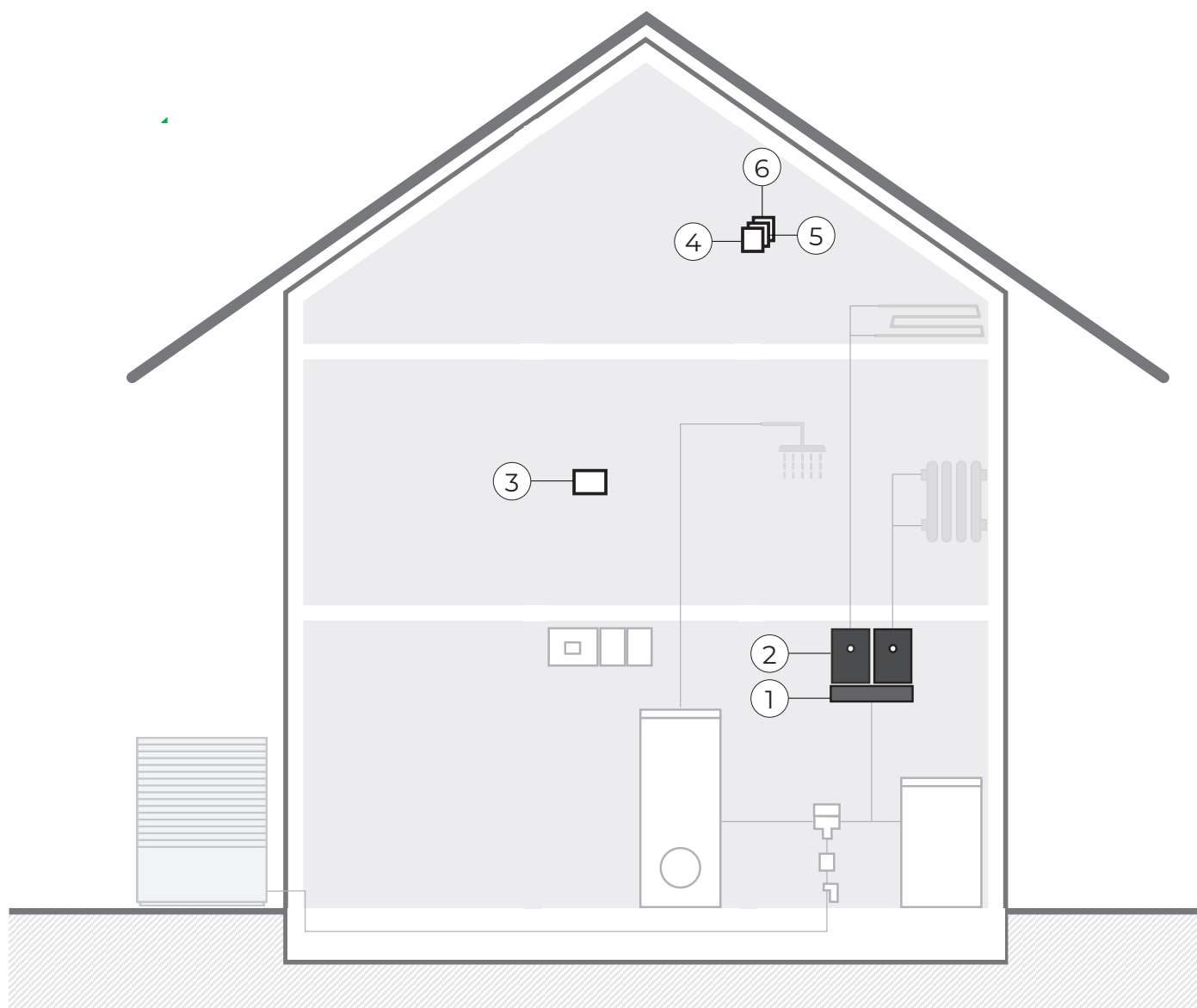

Opis Hidravlični razdelilnik, DN25-2V

Naziv HR_DN25-2V I

Ident 2222000102487



Opis Hidravlični razdelilnik, DN25-3V

Naziv HR_DN25-3V I

Ident 2222000102470

OPREMA ZA OGREVALNI SISTEM



Opis Hidravlični razdelilnik, DN25-4V

Naziv HR_DN25-4V I

Ident 2222000102456



Opis Črpalčni set za ogrevalni krog - direktni

Naziv CS_DN25 D PWM2

Ident 2222000108083

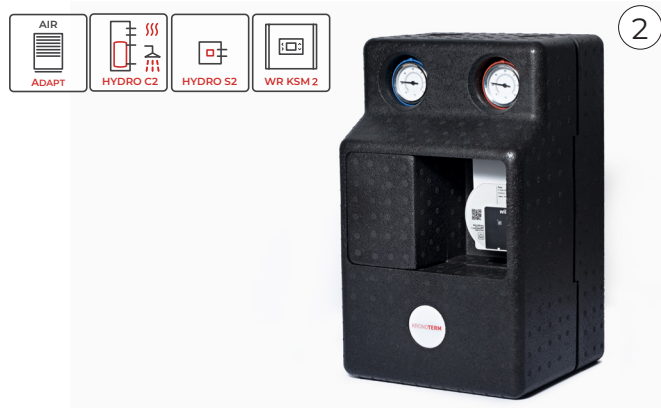

Opis Črpalčni set za ogrevalni krog - mešalni

Naziv CS_DN25 M PWM2

Ident 2222000108090



Opis Stenski sobni termostat in upravljalnik

Naziv KT-2A

Ident 2222000105280

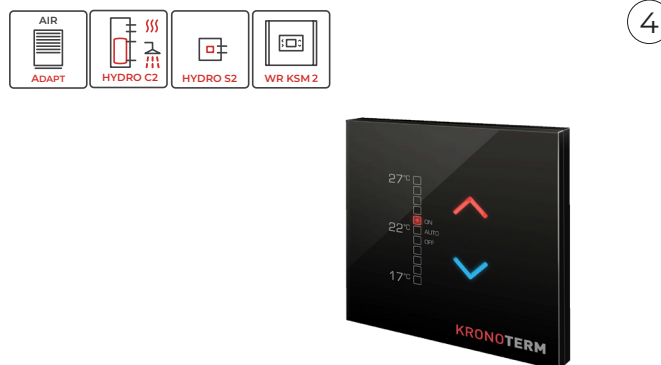

Opis Stenski sobni termostat

Naziv KT-1

Ident 2222000050566

OPREMA ZA OGREVALNI SISTEM



Opis Nadometna doza za KT-1

Naziv ND_KT-1

Ident 2222000048754



Opis Kit za nadgradnjo 2-žilnega kabla za povezavo
KT-1/2A in KSM

Naziv KIT_P2P KT-1/KT-2A

Ident 2222000112844

OPREMA ZA OGREVALNI SISTEM



Opis Visokoučinkovita obtočna črpalka za ogrevalne in hladilne sisteme

Naziv OC_YONOS PICO 25/1-4

Ident 2222000020330



Opis Visokoučinkovita obtočna črpalka za ogrevalne in hladilne sisteme

Naziv OC_YONOS PICO 25/1-6

Ident 2222000019969



Opis Visokoučinkovita obtočna črpalka za toplo sanitarno vodo z navojnim priključkom

Naziv OC_STAR-Z NOVA PN10

Ident 2222000118976



Opis Lotani prenosnik toplote

Naziv LPT_0324

Ident 2222000113223



Opis Lotani prenosnik toplote za pripravo tople sanitarne vode

Naziv LPT_30_TSV

Ident 2222000126216

OPREMA ZA OGREVALNI SISTEM



Opis Hidravlični ločilnik, DN25

Naziv HL_DN25

Ident 2222000102494



Opis Hidravlični ločilnik, DN32

Naziv HL_DN32

Ident 2222000102463



Opis Aditiv za ogrevalne sisteme, za zaščito novih ali starih ogrevalnih sistemov

Naziv AZ_100

Ident 2222000129477



Opis Aditiv za ogrevalne sisteme, za čiščenje novih ali starih ogrevalnih sistemov

Naziv AZ_200

Ident 2222000130749

OPREMA ZA MONTAŽO IN SERVIS

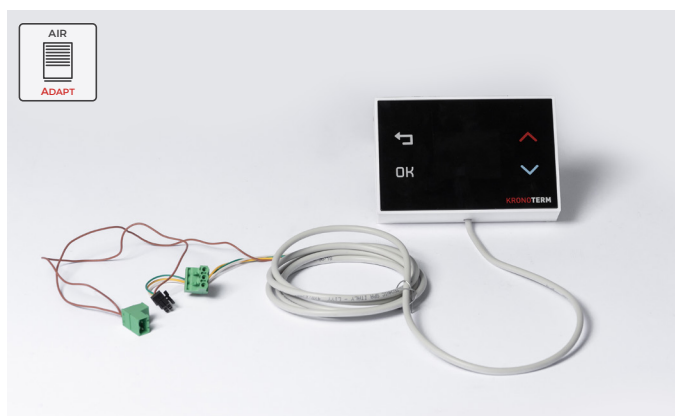

Opis Kit KT-2A za serviserje in izvajalce zagonov

Naziv KIT_SI KT-2A

Ident 2222000132729



Opis Simulator delovanja toplotne črpalke ADAPT

Naziv SD_SIM ADAPT

Ident 2222000108571



Opis Kit za posodabljanje programske opreme z univerzalnim 12 [V] napajalnikom in komunikacijskim vmesnikom za KSM, SecMONO in TT3000

Naziv KIT_PLC MBIO SECMONO

Ident 2222000126162

Kronoterm d.o.o.
Trnava 5e, 3303 Gomilsko, SLO
T +386 3 703 16 20
www.kronoterm.com
info@kronoterm.com