

—
KRONOTERM 1976
HEAT PUMPS



—
DATA SHEET

—
ADAPT^{MAX}
*Air/water heat pump
for commercial and industrial
applications*

Data sheet - ADAPT^{MAX} - EN / 98-24-26-220094-02

This work is protected by copyright.

Any use of this document outside of the copyright and Related Rights Act and without the express consent of KRONOTERM d.o.o. is illegal and punishable by fine.

Despite taking extensive care to ensure the accuracy of all figures and descriptions, KRONOTERM d.o.o. reserves the right to make corrections, changes to technical details, and changes to figures with no prior notice. Information herein is given based on the latest available product information at the time of drafting and printing this document. We also reserve the right to suspend the sales of an individual product or even the entire sales program.

All updates are available in digital format. Please contact your chosen system administrator for access.

Figures are symbolic and are only intended as a reference. Despite our efforts we cannot ensure that the products' true colors, proportions, or other graphical elements will be faithfully represented in print and on electronic screens. Products may differ from their visual representations.

Printed in Slovenia.

The original documentation is written in Slovenian. All other languages are translations.

Write to info@kronoterm.com for any additional questions.

TABLE OF CONTENTS

DESCRIPTION	4
NOMENCLATURE.....	6
CONFIGURATION	7
ADAPT ^{MAX} HEAT PUMP 10035.....	8
ADAPT ^{MAX} HEAT PUMP 10070–10140	10
WR KSM 2 WALL-MOUNTED CONTROL UNIT	12
WR KSM+ WALL-MOUNTED EXPANSION UNIT.....	12
WR KSM C WALL-MOUNTED CONTROL UNIT	13
WR KSM MAX WALL-MOUNTED CONTROL UNIT	13
ADDITIONAL EQUIPMENT ADAPT ^{MAX}	14
Sample installation diagram.....	14
ADDITIONAL EQUIPMENT ADAPT ^{MAX}	15
Configuration matrix ADAPT ^{MAX}	15
ADDITIONAL EQUIPMENT ADAPT ^{MAX}	16
BASIC KSM REGULATOR.....	19
KSM+ EXPANSION REGULATOR.....	19
CONTROL EQUIPMENT.....	20
CLOUD.KRONOTERM.....	21
TECHNICAL DATA	22
SOUND	26
BASIC INSTALLATION DIAGRAM	34
ADAPT ^{MAX} heating and domestic hot water	34
ADAPT ^{MAX} heating, cooling and domestic hot water.....	35
ADAPT ^{MAX} heating and domestic hot water heat pump.....	36
ADAPT ^{MAX} heating, cooling and domestic hot water heat pump.....	37
ADAPT ^{MAX} heating, cooling and domestic hot water with booster	38

WELCOME TO THE KRONOTERM FAMILY!

This data sheet describes the technical features of the ADAPT^{MAX} commercial heat pump system.

DESCRIPTION

The ADAPT^{MAX} heat pump stands out for its efficiency, quiet operation, adaptability, sleek design, and environmental friendliness. Resilience, durability and modularity are at the core of its sustainable design.

It is available in four sizes that can be combined in various configurations for cascade operation, making it suitable for a wide range of applications, from residential buildings to industrial complexes.

The modular design of larger units offers an impressive power range from 10 kW to 140 kW (in cascade up to 8 x 140 kW), ensuring a high level of redundancy and allowing continuous operation even during maintenance of individual components.

Modularity also simplifies maintenance, servicing, spare part cost and availability and faster service technician onboarding.

The advanced technology is meticulously designed in a sleek and compact form. The device is suitable for both residential and commercial applications and seamlessly integrates into the surrounding architecture.

The design maximizes simplicity in planning, installation, operation and maintenance processes.

Usage

The ADAPT^{MAX} heat pump is suitable for floor heating, radiator heating, and fan coil heating, and cooling as well as for domestic hot water preparation.

It achieves an output temperature of up to 75 °C.

Technology

- **MHPTM** - Modular Heat Pump - this modular heat pump offers exceptional flexibility in heating power, ranging from 4% to 100% (depending on the configuration), perfectly matching the needs of any building.
- **HRCOTM** – High Redundancy and Continuous Operation – Individual modules operate both independently and as a whole, ensuring a high level of redundancy and continuous heating and cooling even in the event of a single module failure.
- **BBSTM** – Building Blocks System – features a modular design with standardized interfaces and dimensions.
- **MinimalDesign** – Designed for enduring aesthetics and minimal alteration to the overall spatial appearance.
- **MyDesign** – customizable exterior of the ADAPT^{MAX} outdoor unit, with options for different colors and materials.
- **NMSTTM** – Noise Management System – a system for exceptionally low noise levels that combines a large evaporator with low air resistance, a high-efficiency EC fan with bionic blades, air deflectors, a sound-insulated casing, noise-absorbing and vibration-damping materials, anti-vibration mounting, and specially developed controls.
- **IAHTM** – Intelligent Adaptive Heating – provides perfect adaptability of heating power based on the building's needs. Special control algorithms adjust the water temperature in the heating system according to the desired indoor temperature, current indoor temperature, and current outdoor temperature. The building's response dictates the power level at which the ADAPT^{MAX} heat pump operates. This exceptional flexibility ensures that the device operates almost continuously, moderately, quietly, and comfortably.
- **ECLTM** – Enhanced Compressor Lifetime – The advanced oil recovery system ensures that the heat pump retains lubricant in its compressor, where it is most important. This provides continuous and reliable lubrication, resulting in a longer compressor lifespan. Additionally, the active cooling of the compressor drive using suction vapors prevents overheating of electronic components and enables heat recovery. This contributes to reduced losses and increased system efficiency. At the same time, the compressor range monitoring and protection system constantly keeps the system within safe parameters.
- **CDHRSTM** – Compressor Drive Heat Recovery System – specially designed cooling and waste heat recovery system of the electronic drive of the compressor makes it possible to exceed 96% of its operating efficiency.

- **NZFTM** – Near Zero Frost – the evaporator’s extremely large surface area means that it has very low specific load. This results in reduced extraction of humidity from the air and slower buildup of frost. Less frost means less defrosting, and therefore greater effective heating capacity for the heat pump, and ultimately increased efficiency for the whole system.
- **CWPTM** – Complete Weather Protection – protects the evaporator’s surface and protective guards against climatic conditions while ensuring a constant and appropriate flow of air, first-level protection against indirect precipitation or flash freezes, small amounts of defrosting, higher efficiency, and more reliable operation. Their exceptional construction and advantageous height give ADAPT^{MAX} heat pumps the right amount of airflow through the evaporator even during snowstorms.
- **EASTM** – Easy Access System – easy access to all the main elements of the heat pump from the front and back, which allows easy maintenance and servicing of the device.
- **RASSTM** – Remote Administrator System – remote diagnostics system that can identify malfunctions. Enables remote software updates for flawless operation of the heat pumps.
- **CMSTM** – Cascade Management System enables control and management of all heat pumps connected in the cascade solution via a single interface.
- **CCPTM** – Cool Comfort Plus – active water cooling up to +5 °C as standard.
- **LCLTM** – Life Cycle Longevity – system for exceptional longevity includes the modularity and above-standard components of the heating system, which, with their characteristics and the method of installation in the heat pump, enable an even longer service life.
- **Low GWP** – Global Warming Potential – the heat pump has a low environmental impact, using eco-friendly, non-toxic propane (R290) refrigerant with a GWP100 of 0.02.
- **EcoThriveTM** – Achieving high efficiency with lower operating costs, improved energy balance, and a sustainable design centered on resilience, durability, and modularity for enduring benefits to both the environment and our communities.

NOMENCLATURE

ADAPT^{MAX} 10035 / HK 3F N

ADAPT ^{MAX}	Heat pump family designation
10035	Range of heat output in kW, 10 - 35
10070	Range of heat output in kW, 10 - 70
10105	Range of heat output in kW, 10 - 105
10140	Range of heat output in kW, 10 - 140
HK	Heating and cooling
3F	Three-phase electrical connection 3 x 400 V
N	Colour NERO (Other colors to order)



E

F

G



A

WR KSM 2

WR	Indoor unit designation
KSM	Basic wall-mounted control unit
2	Device generation
KSM MAX	Wall-mounted control unit designed for devices ADAPT MAX 10070-10140
KSM+	Expansion wall-mounted control unit
KSM C	Wall-mounted control unit for additional heat pump in cascade



I



B



C

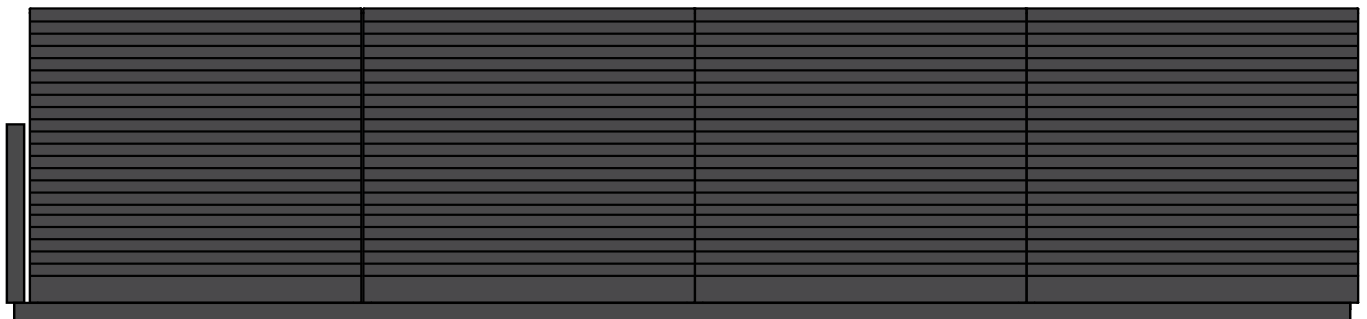

D

Legend:

- A ADAPT^{MAX} 10035
- B ADAPT^{MAX} 10070
- C ADAPT^{MAX} 10105
- D ADAPT^{MAX} 10140
- E WR KSM 2
- F WR KSM+
- G WR KSM C
- I WR KSM MAX 10070 / WR KSM MAX 10105 / WR KSM MAX 10140

CONFIGURATION

ADAPT^{MAX} heat pumps are combined with the WR KSM 2, WR KSM+ and WR KSM C indoor units.

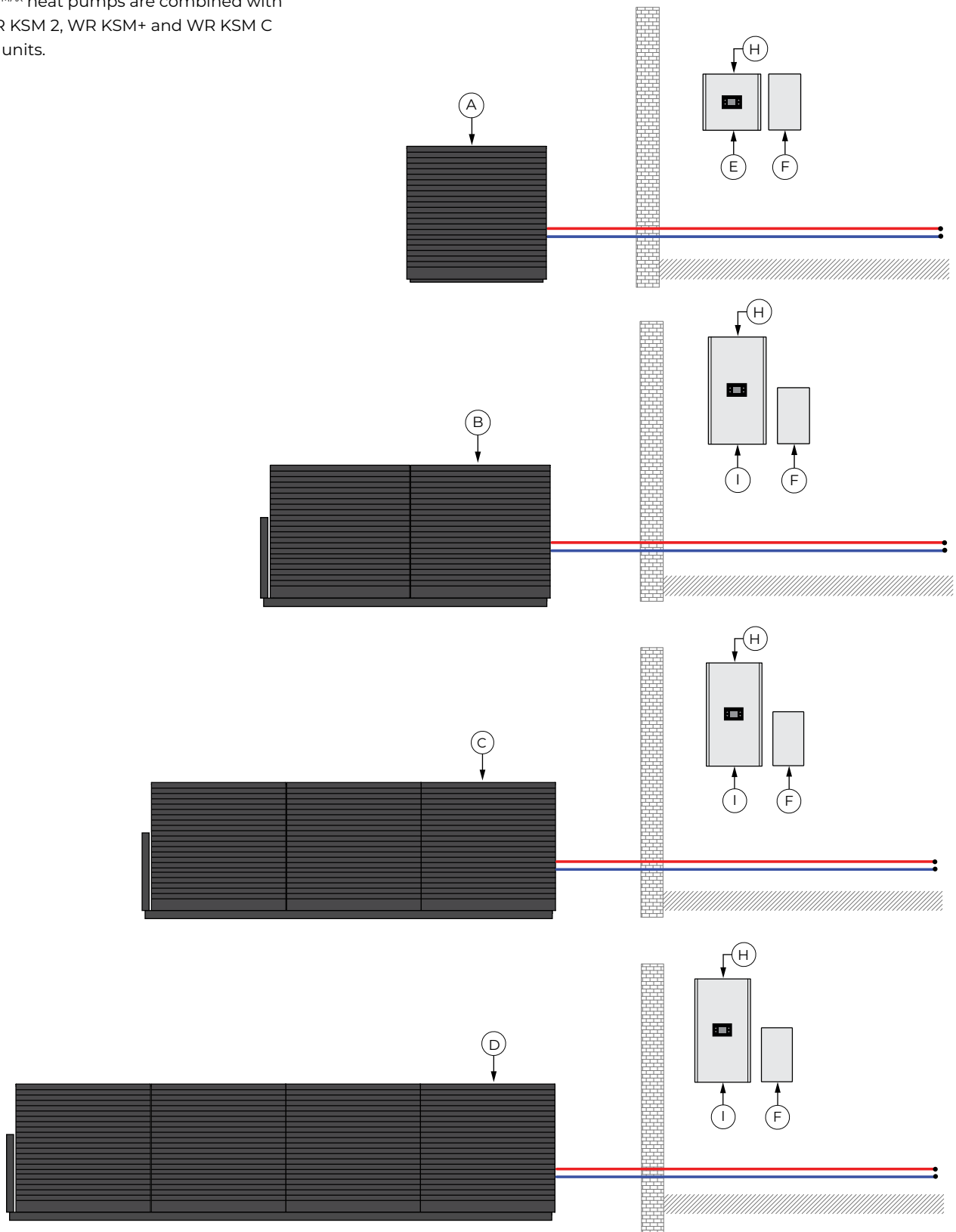

Legend:

- A Heat pump ADAPT^{MAX} 10035
- B Heat pump ADAPT^{MAX} 10070
- C Heat pump ADAPT^{MAX} 10105
- D Heat pump ADAPT^{MAX} 10140
- E WR KSM 2 wall control unit
- F Expansion wall-mounted control unit WR KSM+
- H KT-2A Controller
- I WR KSM MAX 10070 / WR KSM MAX 10105 / WR KSM MAX 10140

ADAPT^{MAX} HEAT PUMP 10035

Version

Compact air/water heat pump.

Model marks

ADAPT^{MAX} 10035 / HK 3F N

Description and dimensions

- Powder coated, galvanised, steel sheet metal housing (NERO by default, other colors to order)
- Optionally made out of stainless steel or CORTEN sheet metal (to order)
- Evaporator and fan protected against the weather
- Bionically designed fan wings for minimum noise pollution
- Adjustable heat output
- Adaptive heating
- Integrated circulation pump
- Large surface area evaporator with enlarged fin spacing for reduced frequency of defrosting
- Special acoustically insulated housing

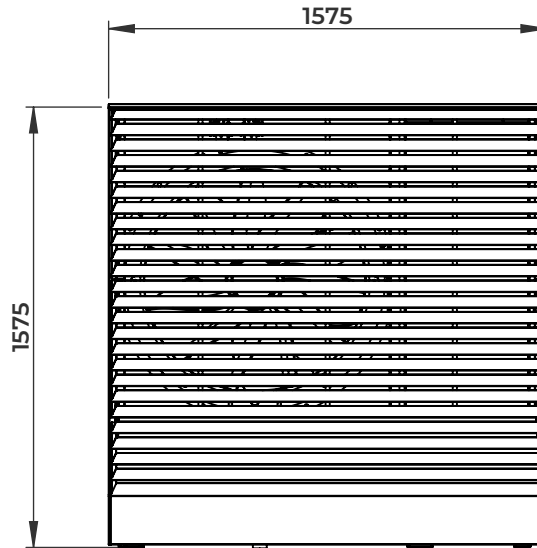

FRONT

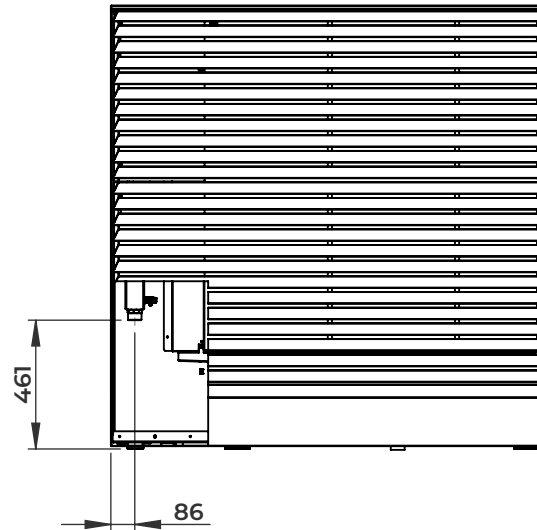

BACK

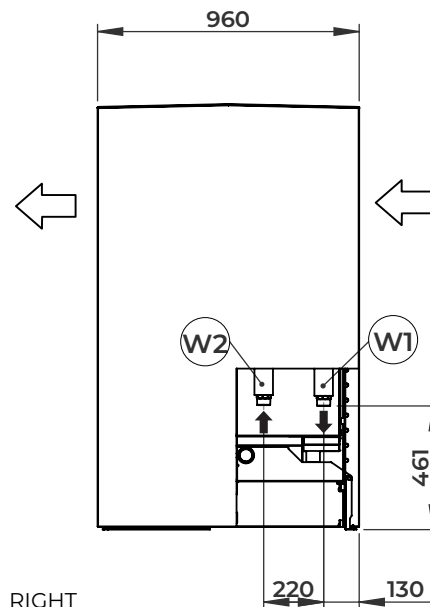

RIGHT

Legend

- W1** Outlet – R 6/4" ET
- W2** Inlet – R 6/4" ET
- Water flow direction
- Air flow direction

ADAPT^{MAX} HEAT PUMP 10035

Primary components

- A** Refrigerant system module:
 - Compressor
 - Condenser
 - Oil separator
 - Electronic expansion valves
 - Compressor drive
 - 4-way valve
 - Filter drier
 - High pressure switch
 - High pressure sensor
 - Low pressure sensor
 - Temperature sensors
 - Compressor drive chokes
- B** Electrical cabinet with the heat pump regulator, communication and power supply terminal blocks.
- C** Cable glands for electrical power supply cable and communication cable.
- D** Circulating pump
- E** Gas separator with safety valve
- F** Flow sensor
- G** Condensate drain

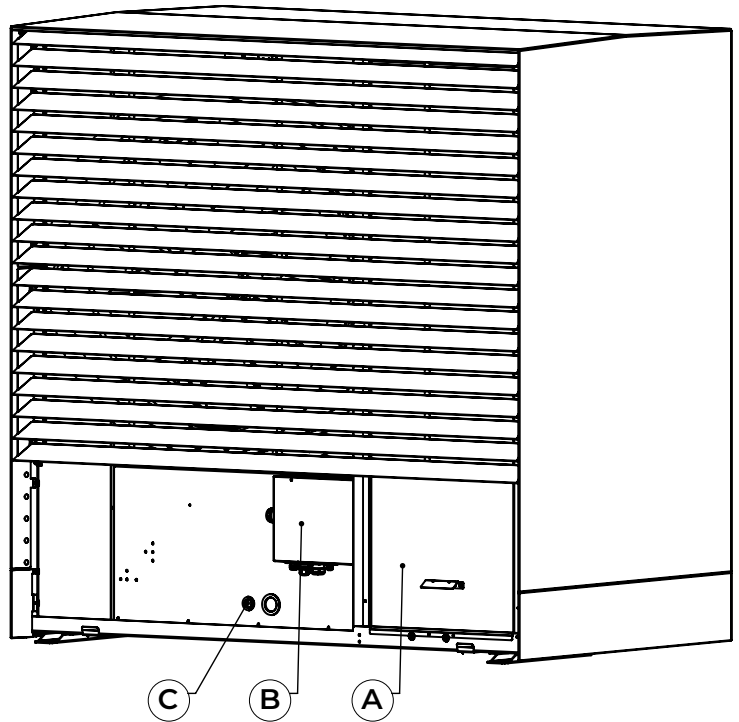

FRONT

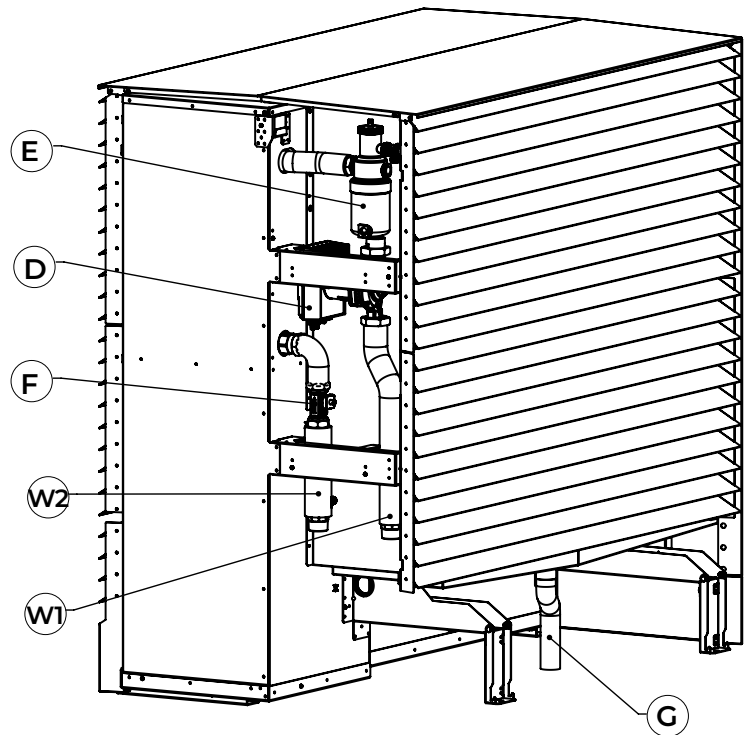

RIGHT

Legend

- W1** Outlet – R 6/4" ET
- W2** Inlet – R 6/4" ET

ADAPT^{MAX} HEAT PUMP 10070-10140

Version

Compact outdoor air/water unit.

Model marks

ADAPT^{MAX} 10070 / HK 3F N

ADAPT^{MAX} 10105 / HK 3F N

ADAPT^{MAX} 10140 / HK 3F N

Description and dimensions

- Powder coated, galvanised, steel sheet metal housing (NERO by default, other colors to order)
- Optionally made out of stainless steel or CORTEN sheet metal (to order)
- Evaporator and fan protected against the weather
- Bionically designed fan wings for minimum noise pollution
- Adjustable heat output
- Adaptive heating
- Integrated circulation pump
- Large surface area evaporator with enlarged fin spacing for reduced frequency of defrosting
- Special acoustically insulated housing

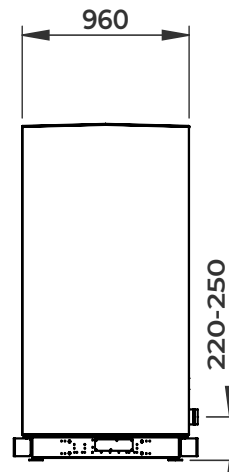
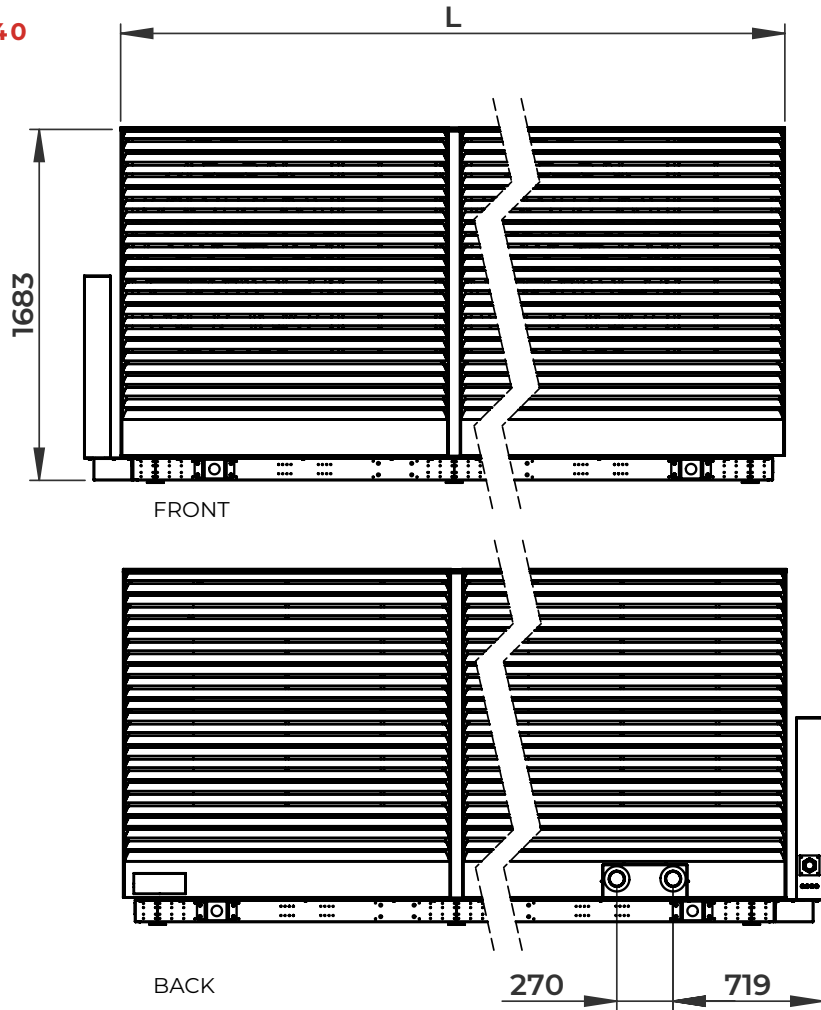

RIGHT

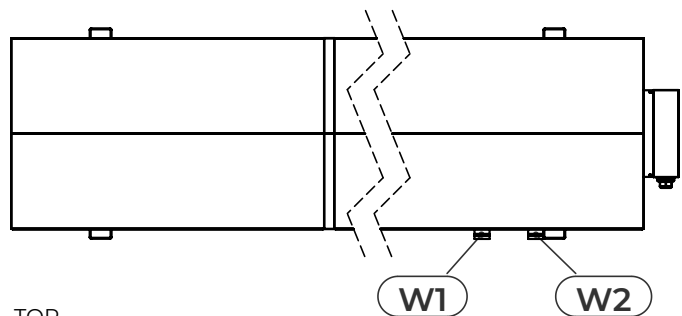

TOP

Legend

- L** ADAPT MAX 10070 - 3375 mm
ADAPT MAX 10105 - 5000 mm
ADAPT MAX 10140 - 6625 mm

W1 Outlet - DN65 Victaulic

W2 Inlet - DN65 Victaulic

◀ Water flow direction

↶ Air flow direction

ADAPT^{MAX} HEAT PUMP 10070-10140

Primary components

- G** Condensate drain
- H** Ball valve
- I** Power supply and communication electrical cabinet

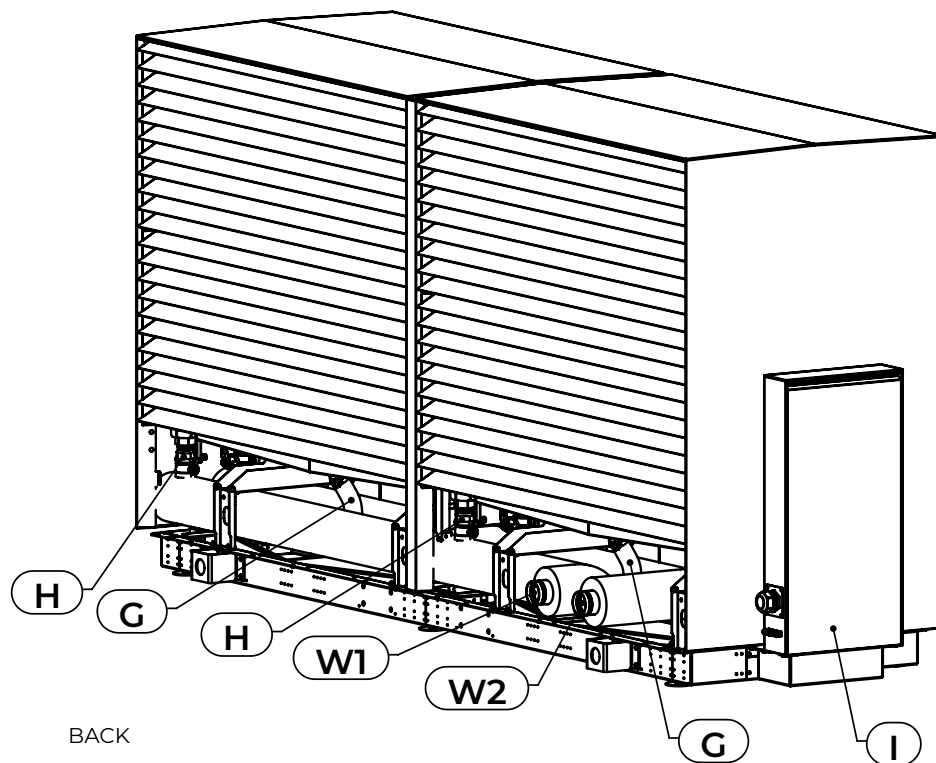

Legend

- W1** Outlet - DN65 Victaulic
- W2** Inlet - DN65 Victaulic

WR KSM 2 WALL-MOUNTED CONTROL UNIT

Version

Basic wall-mounted unit

Model

WR KSM 2

Description and dimensions

- Wall-mounted indoor unit
- KSM regulator
- Integrated WEB module

Functional characteristics

- Register a heat pump with CLOUD. KRONOTERM
- Manage a heat pump the cloud-based CMSTM management system

Legend

- 1 Conduits for control cable
- 2 Internet cable jack
- 3 Threaded power cable conduit
- 4 KT-2A controller

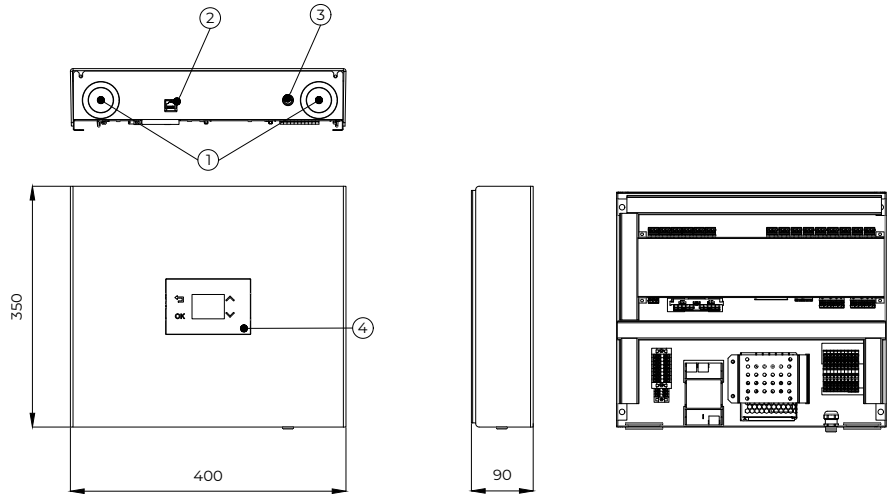

WR KSM+ WALL-MOUNTED EXPANSION UNIT

Version

Expansion wall-mounted unit

Model

WR KSM+

Description and dimensions

- Wall-mounted indoor unit
- Regulator KSM+

Legend

- 1 Conduits for control cable

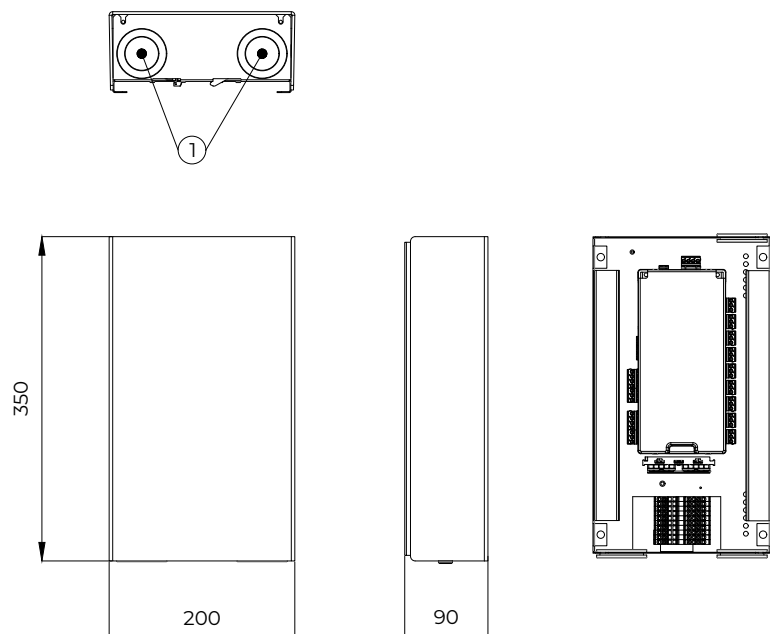

WR KSM C WALL-MOUNTED CONTROL UNIT

Version

Indoor unit for activating an additional heat pump in cascade.

Model

WR KSM C

Description and dimensions

- Wall-mounted indoor unit
- Integrated WEB module

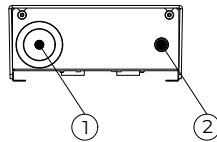

Functional characteristics

- Activate an additional heat pump in cascade
- Register a heat pump with CLOUD.KRONOTERM
- Manage a heat pump in cascade via the cloud-based CMSTM management system

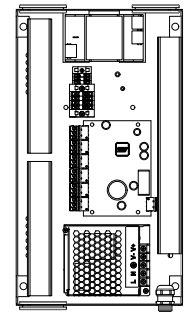
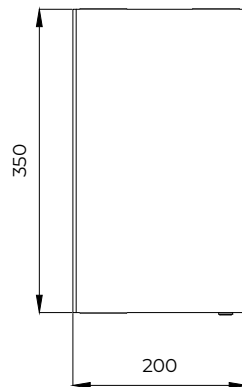

Legend

- 1 Conduits for control cable
- 2 Threaded power cable conduit

WR KSM MAX WALL-MOUNTED CONTROL UNIT

Version

Wall-mounted unit

Model

WR KSM MAX 10070
WR KSM MAX 10105
WR KSM MAX 10140

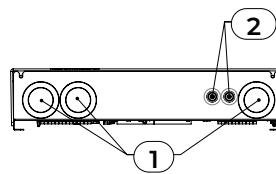

Description and dimensions

Wall-mounted indoor unit for ADAPT MAX 10070 to 10140

- KSM regulator
- Integrated WEB module

Functional characteristics

- Register a heat pump with CLOUD.KRONOTERM
- Activate and manage heat pump modules via the cloud-based CMSTM management system

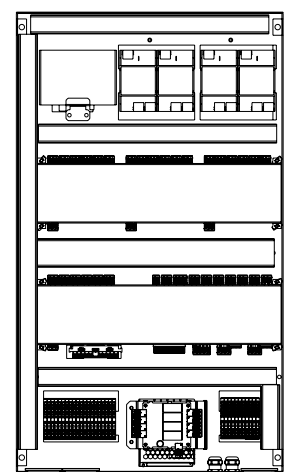
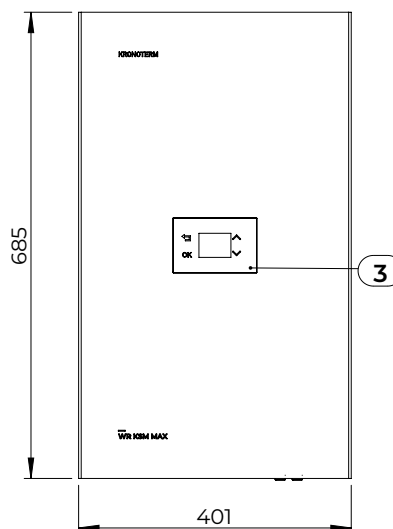

Legend

- 1 Conduits for control cable
- 2 Threaded power cable conduit
- 3 KT-2A Controller

ADDITIONAL EQUIPMENT ADAPT^{MAX}

Sample installation diagram

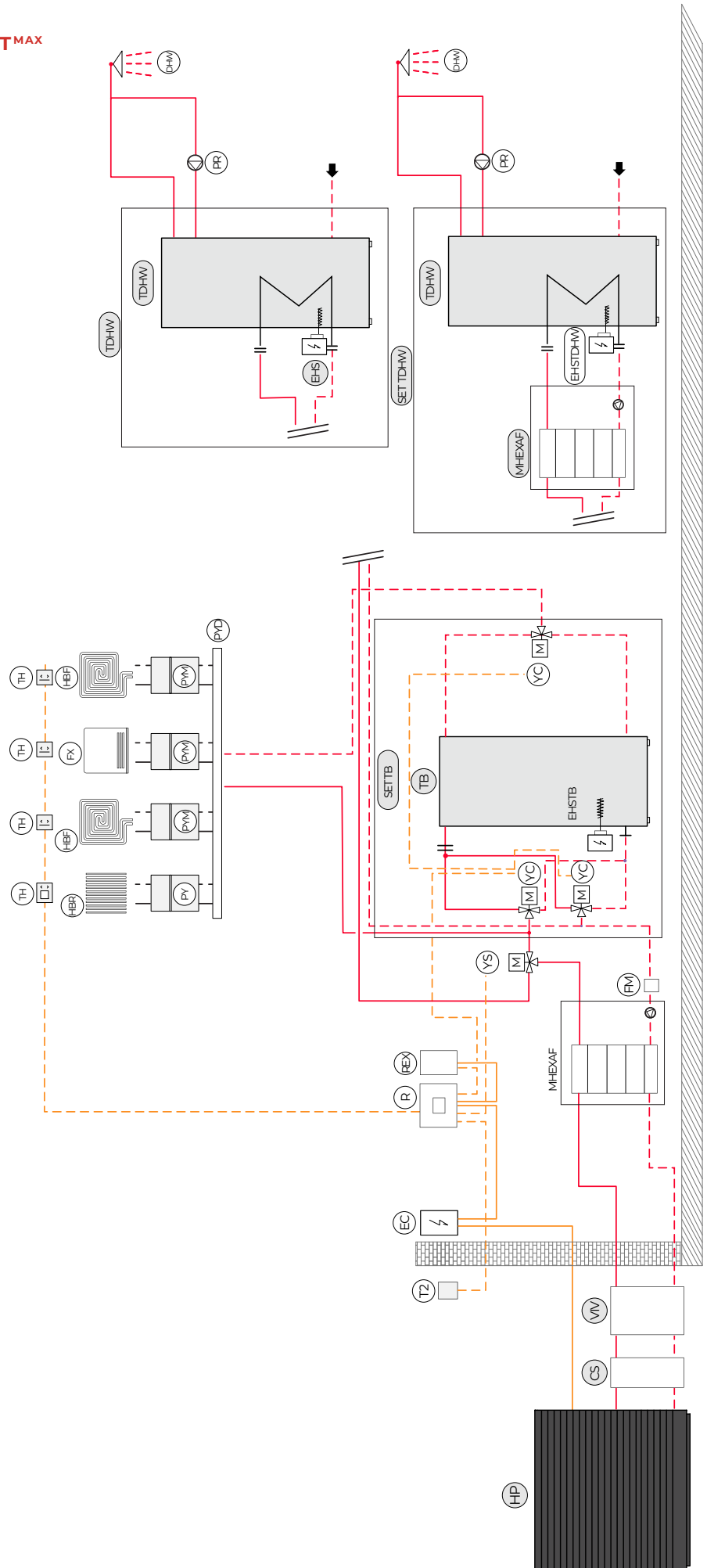

ADDITIONAL EQUIPMENT ADAPT^{MAX}

Configuration matrix ADAPT^{MAX}

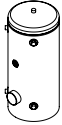
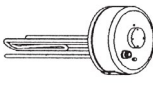
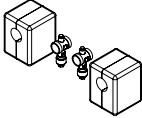
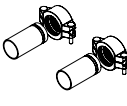
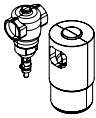
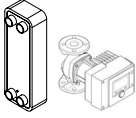
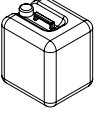
				EQUIPMENT FOR OPERATION WITH ANTI-FREEZE FLUID				
		Buffer tank (set)	Electric heater buffer tank	Anti-freeze valve (set)	Connection set	Magnetic dirt separator	Anti-freeze fluid heat exchanger set	Anti-freeze fluid
HP		TB	EHSTB	VIV	CS	FM	MHEXDHW	TPT
								
ADAPT ^{MAX} 10035	Heating	ZA_500 DN50 ZA_1000 DN65 ZA_1500 DN80 ZA_2000 DN100	PEG_RSW 1-15 PEG_RSW 2-24 U	SET_VIV 10035	N/A	MLN_UE200WJ	PA_LPTAF 3045	TPT_EG
	Heating and Cooling	PA_ZA 500 50 PA_ZA 1000 50 PA_ZA 1500 50 PA_ZA 2000 50	PEG_RSW 1-15 PEG_RSW 2-24 U					
ADAPT ^{MAX} 10070	Heating	ZA_500 DN50 ZA_1000 DN65 ZA_1500 DN80 ZA_2000 DN100	PEG_RSW 1-15 PEG_RSW 2-24 U	SET_VIV 10070 - 10140	SET_W1-W2 VIC ADAPT MAX	MLN_BE050FM	PA_LPTAF 8090	TPT_EG
	Heating and Cooling	PA_ZA 500 50 PA_ZA 1000 50 PA_ZA 1500 50 PA_ZA 2000 50	PEG_RSW 1-15 PEG_RSW 2-24 U					
ADAPT ^{MAX} 10105	Heating	ZA_1000 DN65 ZA_1500 DN80 ZA_2000 DN100	PEG_RSW 2-45 U	SET_VIV 10070- 10140	SET_W1-W2 VIC ADAPT MAX	MLN_BE065FM	PA_LPTAF 110	TPT_EG
	Heating and Cooling	PA_ZA 1000 65 PA_ZA 1500 65 PA_ZA 2000 65	PEG_RSW 2-45 U					
ADAPT ^{MAX} 10140	Heating	ZA_1000 DN65 ZA_1500 DN80 ZA_2000 DN100	PEG_RSW 2-45 U	SET_VIV 10070- 10140	SET_W1-W2 VIC ADAPT MAX	MLN_BE080FM	PA_LPTAF 2X8090	TPT_EG
	Heating and Cooling	PA_ZA 1000 65 PA_ZA 1500 65 PA_ZA 2000 65	PEG_RSW 2-45 U					

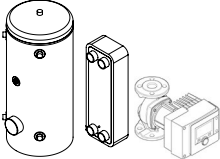
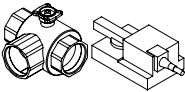
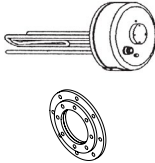
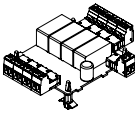
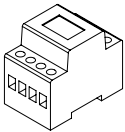
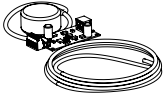
DHW EQUIPMENT				ELECTRO MODULES			
		DHW tank (set)	DHW motorised zone valve (set)	Electric heater DHW tank (set)	Regulator for pumps without PWM signal	Electric power meter	2-wire KT-2A connection power supply kit
HP		TDHW	YS	EHSTDHW			
							
ADAPT ^{MAX} 10035		BO_500 P BO_1000 P PA_BO 1500 45 PA_BO 1500 70 PA_BO 2000 45 PA_BO 2000 70	PA_TPV DN40 2P	PEG_EBH-KDW1 10,0 PA_PEG EBH-KDW1 10,0	WR PWM-R	EO_WM3-6	KIT_P2P KT-1/KT-2A
	ADAPT ^{MAX} 10070	PA_BO 1500 70 PA_BO 2000 70	PA_TPV DN50 2P	PA_PEG EBH-KDW1 10,0	WR PWM-R	/	KIT_P2P KT-1/KT-2A
ADAPT ^{MAX} 10105		CUSTOM PROJECT	CUSTOM PROJECT	CUSTOM PROJECT	WR PWM-R	/	KIT_P2P KT-1/KT-2A
ADAPT ^{MAX} 10140		CUSTOM PROJECT	CUSTOM PROJECT	CUSTOM PROJECT	WR PWM-R	/	KIT_P2P KT-1/KT-2A

ADDITIONAL EQUIPMENT ADAPT^{MAX}

Equipment for the heating system

BUFFER TANK

For heating. Available in 4 sizes:

- 500 l: ZA_500 DN50
- 1000 l: ZA_1000 DN65
- 1500 l: ZA_1500 DN80
- 2000 l: ZA_2000 DN100

Includes: buffer tank with vapor barrier insulation

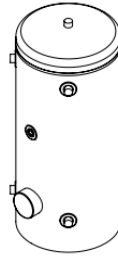

BUFFER TANK SET

For heating and cooling. Available in 7 configurations:

- 500 l:
PA_ZA 500 50 (with zone valve)
- 1000 l:
PA_ZA 1000 50 (with zone valve)
PA_ZA 1000 65 (with butterfly valve)
- 1500 l:
PA_ZA 1500 50 (with zone valve)
PA_ZA 1500 65 (with butterfly valve)
- 2000 l:
PA_ZA 2000 50 (with zone valve)
PA_ZA 2000 65 (with butterfly valve)

Includes: Buffer tank with vapor barrier insulation, 3x zone valve or 6x butterfly valve, electro-motor drive

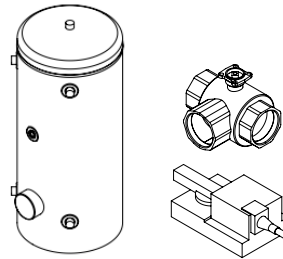

ELECTRIC HEATER BUFFER TANK

Available in 3 sizes:

- PEG_RSW 1-15
- PEG_RSW 2-24 U
- PEG_RSW 2-45 U

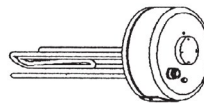

ANTI-FREEZE VALVE SET

- SET_VIV 10035

Includes: 2x anti-freeze valve, 2x thermal insulation

- SET_VIV 10070-10140

Includes: 2x anti-freeze valve, 2x connection piece, 2x Victaulic coupling

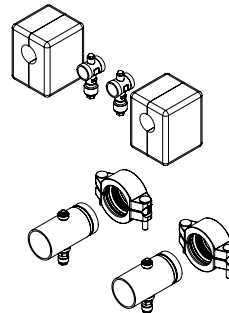

CONNECTION SET

Set of connections for transition from VIC DN65 to Φ 76,1 thread.

- SET_W1-W1 VIC ADAPT MAX

Includes: 2x adapter piece DN65 - Φ 76,1
2x Victaulic coupling DN65

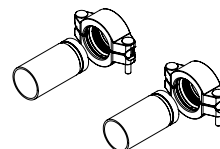

MAGNETIC DIRT SEPARATOR

Available in 4 sizes:

- MLN_UE200WJ
- MLN_BE050FM
- MLN_BE065FM
- MLN_BE080FM

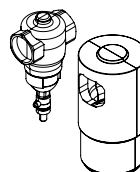

DHW equipment

DHW TANK - Available in 2 sizes:

- 500 l: BO_500 P
- 1000 l: BO_1000 P

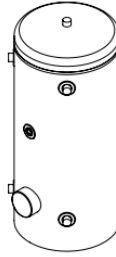

DHW TANK SET

DHW tank with equipment for heating sanitary water using an external heat exchanger.

Available in 4 sizes:

- 1500 l:
 - PA_BO 1500 45 (max. 40 kW)
 - PA_BO 1500 70 (max. 70 kW)
- 2000 l:
 - PA_BO 2000 45 (max. 40 kW)
 - PA_BO 2000 70 (max. 70 kW)

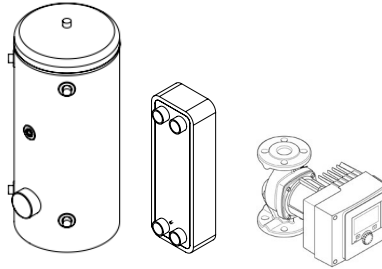

Includes: DHW tank, plate heat exchanger, domestic water circulation pump

DHW MOTORISED ZONE VALVE SET

Available in 2 sizes:

- PA_TPV DN40 2P
- PA_TPV DN50 2P

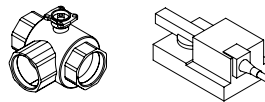

Includes: 3-way zone valve, electro-motor drive

DHW TANK ELECTRIC HEATER

- PEG_EBH-KDW110,0

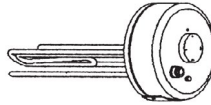

DHW TANK ELECTRIC HEATER SET

- PA_PEG EBH-KDW110,0

Includes: el. heater, flange

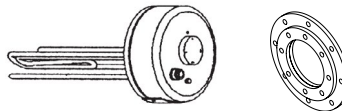

ADDITIONAL EQUIPMENT ADAPT^{MAX}

Equipment for operation with anti-freeze fluid

ANTI-FREEZE FLUID EQUIPMENT SET

Available in 4 sizes:

- SET_LPTAF_3045
- SET_LPTAF_5570
- SET_LPTAF_110
- SET_LPTAF_2X8090

Includes: insulated plate heat exchanger, heat exchanger brackets, circulation pump

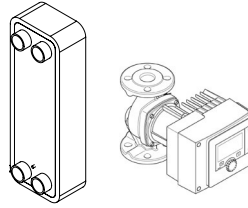

ANTI-FREEZE FLUID

- TPT_EG

Volume: 10 l

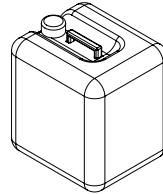

Electro modules

MODULE WR PWM-R

Relay module for regulating circulation pumps without PWM signal.

Integration into WR KSM unit.

The relay module converts the continuous signal into an ON/OFF signal.

Includes: relay module (converter), cables, spacers

- WR PWM-R

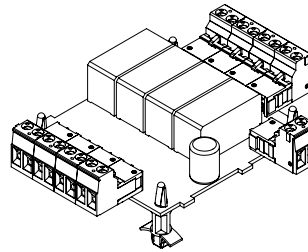

ELECTRICITY METER

Electricity meter for installation in the building's electrical power supply cabinet.

Measurement of the electric power of the heat pump and monitoring of actual electricity consumption in CLOUD.KRONOTERM (instead of displaying calculated energy consumption values).

- EO_WM3-6

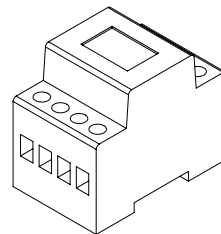

KIT FOR UPGRADING A 2-WIRE

CABLE

Kit for connecting KT-2A or KT-1 to a 2-wire instead of 4-wire cable.

Includes: power supply, optical separator, cable for optical separator

- KIT_P2P KT-1/KT-2A

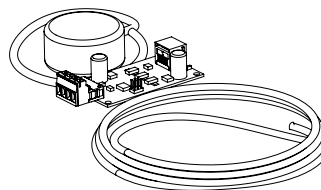

BASIC KSM REGULATOR

Model mark

KSM (KRONOTERM System Manager)

Description

Basic heat pump and heating system regulator.
Control via the KT-2A controller or the
CLOUD.KRONOTERM mobile/web application.

Functional characteristics

- Heat pump control.
- Control of additional heat generators (gas, oil or pellet boiler).
- Circulation control.
- Domestic water heating.
- Domestic water thermal disinfection.
- Adaptive weather control of individual loops based on outdoor and room temperature (requirement: accessory KT-1 or KT-2A).
- Active cooling.
- Usage of excess energy from the PV module (PV program).
- Screed-drying program.
- Control functions for:
 - 1x direct loop (radiators/convectors/in-floor heating);
 - 1x direct or mixing loop (radiators/convectors/in-floor heating);
 - room temperature regulation with KT-1 and KT-2A;
 - daily and weekly schedules.
- WEB module for internet connection (RJ45 connection – Ethernet).
- BMS connection via MODBUS RS485 protocol.
- Smart-grid ready (SG ready).

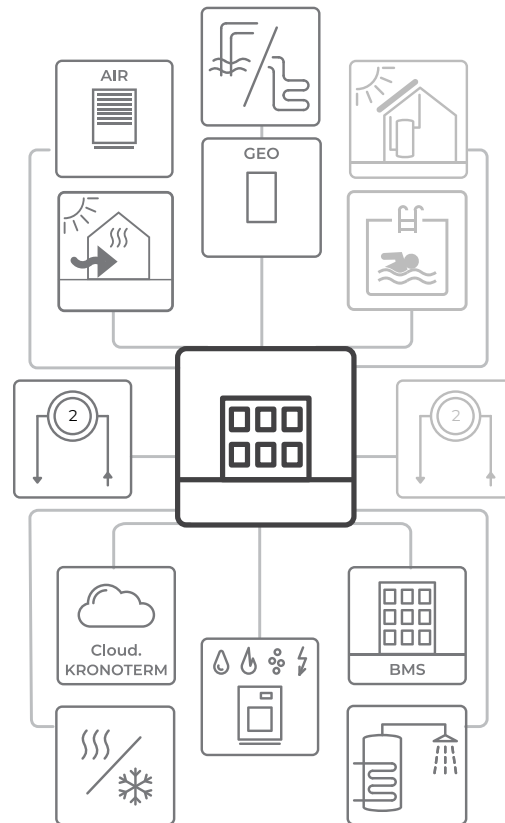

KSM+ EXPANSION REGULATOR

Model mark

KSM+ (KRONOTERM System Manager+)

Functional characteristics

- Managing 2 additional heating loops (direct or mixed).
- Utilizing the heat of solar collectors.
- Utilizing the heat of biomass boilers (wood chips).
- Pool heating.
- Pool heating with solar collectors.

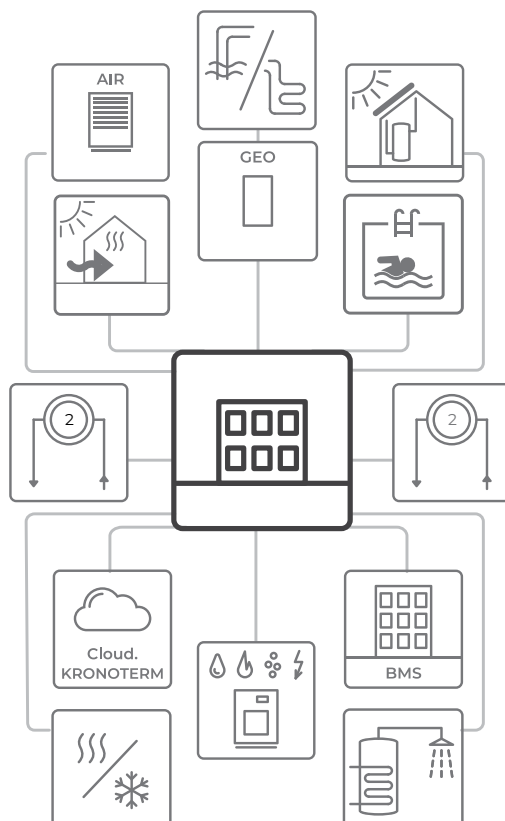

CONTROL EQUIPMENT

KT-2A CONTROLLER

Model mark

KT-2A

Description and dimensions

To operate the heat pump and heating system.

Functional characteristics

- To operate the heat pump modules and heating system.
- Control and setting of all heating/cooling loops.
- Control and setting of DHW.
- Control and setting of room temperature.
- Operating status indicators.
- Service access and troubleshooting.
- Ambient temperature measurement and display.
- Weather forecast.
- Night mode.
- Measurement accuracy: 0.1 °C.
- Setting step: 0.1 °C.
- Modbus RS485 cable connection.
- Color LCD display and capacitive keys.
- Depending on the settings, the KT-2A controller can be used in three operating modes: as a thermostat, controller of the heat pump and the heating system, thermostat and controller of the heat pump and the heating system.

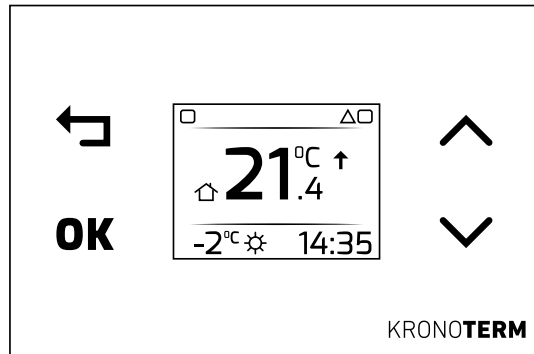

KT-2A controller (W: 122, H: 80, D: 8.6)

TERMOSTAT KT-1

Model mark

KT-1

Description and dimensions

Control and setting of room temperature and operation of each individual heating/cooling loop.

Functional characteristics

- Room temperature measurement and display.
- Room temperature setting.
- Operation mode of the heating loop (OFF/ON/AUTO).
- Night mode.
- Measurement accuracy: 0.1 °C.
- Setting step: 0.5 °C.
- Setting range: 17-27 °C.
- Modbus RS485 cable connection.
- LED illumination and capacitive keys.

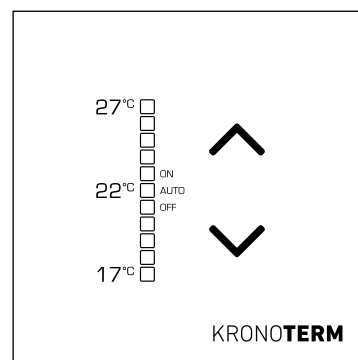

KT-1 thermostat (W: 80, H: 80, D: 8.6)

CLOUD.KRONOTERM

Description

CLOUD.KRONOTERM gives you oversight and control over your heat pump, its heating loops, and its consumption and operational costs. The only condition is that your appliance be connected to the internet.

Recording all events and over 30 operational parameters gives the support team a comprehensive overview and instantaneous diagnostics in the event of a malfunction. All of the data collected are used for permanent improvements which automatically get fed into the appliance, increasing your comfort and lowering operational costs.

CLOUD.KRONOTERM makes your already installed appliance smarter and better.

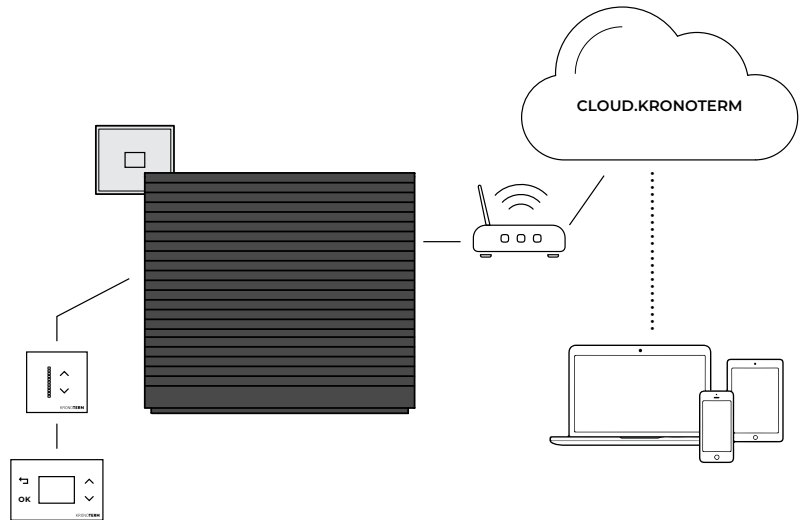

Functional characteristics

- The CLOUD.KRONOTERM mobile or web application is a clear and transparent graphic interface, with which you can easily set the desired room or domestic water temperatures.
- Temperature setting step: 0.1 °C.
- In the app, user can also set:
 - daily and weekly schedule;
 - heat pump operation mode;
 - screed drying;
 - pool heating;
 - anti-legionella program;
 - holiday program, ...
- In the application, users monitor indicators such as:
 - heat pump heating power;
 - operating hours of heating, cooling, passive cooling, additional heater 1 and/or additional heater 2 and outdoor temperature;
 - theoretical electricity consumption energy for individual components of the heating system;
 - information, warnings and alarms about the operation of the heat pump.
- The app makes it easy for the user to connect to remote diagnostics support.

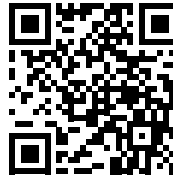

Test of the web app demo version:

USER NAME: demo2

PASSWORD: demo2



Test of the mobile app

demo version HOME.CLOUD:

USER NAME: demo2

PASSWORD: demo2



TECHNICAL DATA

DEVICE	Unit	ADAPT ^{MAX} 10035	ADAPT ^{MAX} 10070	ADAPT ^{MAX} 10105	ADAPT ^{MAX} 10140
DEDICATED INDOOR UNIT					
Dedicated indoor unit		WR KSM 2, WR KSM C, WR KSM+	WR KSM MAX 10070, WR KSM+	WR KSM MAX 10105, WR KSM+	WR KSM MAX 10140, WR KSM+
VERSION					
Heat source		Air	Air	Air	Air
Heat sink		Water / Water-ethylene glycol 30%	Water / Water-ethylene glycol 30%	Water / Water-ethylene glycol 30%	Water / Water-ethylene glycol 30%
Controller		KSM	KSM	KSM	KSM
Heat pump location		Outdoor	Outdoor	Outdoor	Outdoor
Controller position		In the indoor unit	In the indoor unit	In the indoor unit	In the indoor unit
Compressor		1 x scroll with variable speed	2x scroll with variable speed	3x scroll with variable speed	4x scroll with variable speed
Compressor drive		DC Inverter	DC Inverter	DC Inverter	DC Inverter
Fan		1x Axial with with variable flow	2x Axial with with variable flow	3x Axial with with variable flow	4x Axial with with variable flow
Defrosting		Active (refrigerant changes direction)	Active (refrigerant changes direction)	Active (refrigerant changes direction)	Active (refrigerant changes direction)
Circulation pump		Integrated	Integrated	Integrated	Integrated
Water flow sensor		Integrated	Integrated	Integrated	Integrated
Pressure sensor		Optional (Additional equipment)	Optional (Additional equipment)	Optional (Additional equipment)	Optional (Additional equipment)

CAPACITY ACCORDING TO STANDARD EN 14511

HEATING		Heating capacity / electrical power / COP	Heating capacity / electrical power / COP	Heating capacity / electrical power / COP	Heating capacity / electrical power / COP
A7/W30-35, part load ¹	kW/kW/-	26,77 / 5,02 / 5,33	53,48 / 10,04 / 5,33	80,19 / 15,06 / 5,33	106,90 / 20,08 / 5,32
A7/W30-35, max. capacity ²	kW/kW/-	35,40 / 7,29 / 4,86	70,74 / 14,58 / 4,85	106,09 / 21,86 / 4,85	141,43 / 29,15 / 4,85
A-7/W30-35, max. capacity ²	kW/kW/-	32,49 / 11,28 / 2,88	64,98 / 22,56 / 2,88	97,47 / 33,84 / 2,88	129,96 / 45,12 / 2,88
A-10/W47-55, max. capacity ²	kW/kW/-	31,12 / 15,12 / 2,06	62,22 / 33,35 / 2,05	93,30 / 45,51 / 2,05	125,40 / 60,68 / 2,05
A-7/W47-55, max. capacity ²	kW/kW/-	33,62 / 15,84 / 2,12	67,24 / 31,68 / 2,12	100,86 / 47,52 / 2,12	134,48 / 63,36 / 2,12
A7/W47-55, part load ¹	kW/kW/-	26,49 / 7,63 / 3,47	52,92 / 15,27 / 3,47	79,10 / 22,90 / 3,46	105,79 / 30,54 / 3,46
A7/W47-55, max. capacity ²	kW/kW/-	34,94 / 11,05 / 3,16	69,81 / 22,11 / 3,16	104,68 / 33,16 / 3,16	139,56 / 36,18 / 3,16
A-10/W30-35, max. capacity ²	kW/kW/-	30,26 / 10,90 / 2,78	60,50 / 21,84 / 2,77	90,80 / 32,77 / 2,77	121,05 / 43,70 / 2,77
COOLING		Cooling capacity / electrical power / EER	Cooling capacity / electrical power / EER	Cooling capacity / electrical power / EER	Cooling capacity / electrical power / EER
A35/W12-7, part load ¹	kW/kW/-	30,30 / 11,03 / 2,75	60,54 / 22,07 / 2,74	90,77 / 33,10 / 2,74	121,01 / 44,13 / 2,74
A35/W23-18, part load ¹	kW/kW/-	30,13 / 6,51 / 4,63	60,20 / 13,02 / 4,62	90,27 / 19,53 / 4,62	120,33 / 26,04 / 4,62
A35/W12-7, max. capacity ²	kW/kW/-	35,62 / 15,36 / 2,32	71,18 / 30,72 / 2,32	106,74 / 46,08 / 2,32	142,30 / 61,44 / 2,32
A35/W23-18, max. capacity ²	kW/kW/-	35,43 / 8,82 / 4,02	70,80 / 17,64 / 4,01	106,17 / 26,46 / 4,01	141,54 / 35,28 / 4,01

¹ Standard rating condition, part load

² Operation at maximum capacity

DEVICE	Unit	ADAPT ^{MAX} 10035	ADAPT ^{MAX} 10070	ADAPT ^{MAX} 10105	ADAPT ^{MAX} 10140
SEASONAL ENERGY EFFICIENCY FOR HEATING ACCORDING TO DIRECTIVE (EU) 811/2013 – DATA SHEET					
Temperature mode	°C	35/55	35/55	35/55	35/55
Seasonal energy efficiency class		A+++ / A+++	A+++ / A+++	A+++ / A+++	A+++ / A+++
Rated heating capacity P _{designh} , average climate zone	kW	27 / 27	53 / 53	80 / 80	106 / 106
Seasonal space heating energy efficiency η _s , average climate zone	%	230 / 171	229 / 171	229 / 171	229 / 171
Annual energy consumption average climate zone	kWh	9406 / 12562	18854 / 25178	28316 / 38081	37765 / 50814
Level of sound power L _{WA} , indoor	dB	-	-	-	-
Rated heating capacity P _{designh} , colder climate zone	kW	31 / 31	62 / 62	94 / 93	125 / 125
Rated heating capacity P _{designh} , warmer climate zone	kW	32 / 32	64 / 64	97 / 96	129 / 128
Seasonal space heating energy efficiency η _s , colder climate zone	%	193 / 150	193 / 150	193 / 149	193 / 149
Seasonal space heating energy efficiency η _s , warmer climate zone	%	303 / 216	302 / 216	302 / 216	302 / 216
Annual energy consumption, colder climate zone	kWh	15514 / 20008	31386 / 40095	47153 / 60264	62827 / 81016
Annual energy consumption, warmer climate zone	kWh	5632 / 7796	11359 / 15635	16924 / 23466	22623 / 31288
Level of sound power L _{WA} , outdoor	dB	49 / 50	52 / 53	54 / 55	55 / 56

SEASONAL ENERGY EFFICIENCY FOR HEATING ACCORDING TO DIRECTIVE (EU) 811/2013 – DATA SHEET FOR COMPLETE SPATIAL HEATERS

Controller model		KSM	KSM	KSM	KSM
Temperature mode	°C	35/55	35/55	35/55	35/55
Class of controller for adjusting temperature		VI	VI	VI	VI
Temperature controller's contribution to seasonal efficiency	%	4,0	4,0	4,0	4,0
Seasonal energy efficiency class for packages of space heaters		A+++ / A+++	A+++ / A+++	A+++ / A+++	A+++ / A+++
Seasonal space heating energy efficiency η _s for packages of space heater, average climate zone	%	234 / 175	233 / 175	233 / 175	233 / 175
Seasonal space heating energy efficiency η _s for packages of space heater, colder climate zone	%	197 / 154	197 / 154	197 / 153	197 / 153
Seasonal space heating energy efficiency η _s for packages of space heater, warmer climate zone	%	307 / 220	306 / 220	306 / 220	306 / 220

SEASONAL HEATING PERFORMANCE ACCORDING TO STANDARD EN 14825

Rated heating capacity P _{designh} 35 °C / 55 °C – average climate zone	kW / kW	27 / 27	53 / 53	80 / 80	106 / 106
SCOP, 35 °C/55 °C – average climate zone		5,82 / 4,36	5,81 / 4,35	5,80 / 4,34	5,80 / 4,34
Rated heating capacity P _{designh} 35 °C / 55 °C – warmer climate zone	kW / kW	32 / 32	64 / 64	97 / 96	129 / 128
SCOP, 35 °C/55 °C – warmer climate zone		7,64 / 5,48	7,62 / 5,47	7,62 / 5,47	7,62 / 5,47
Rated heating capacity P _{designh} 35 °C / 55 °C – colder climate zone	kW / kW	31 / 31	62 / 62	94 / 93	125 / 125
SCOP, 35 °C/55 °C – colder climate zone		4,91 / 3,82	4,90 / 3,81	4,89 / 3,80	4,89 / 3,80

SEASONAL COOLING PERFORMANCE ACCORDING TO STANDARD EN 14825

Rated cooling capacity P _{designh} 7°C / 18°C	kW / kW	30 / 30	61 / 60	91 / 90	121 / 120
SEER, 7°C / 18°C		5,43 / 8,01	5,41 / 8,00	5,41 / 7,98	5,41 / 7,98

DEVICE	Unit	ADAPT ^{MAX} 10035	ADAPT ^{MAX} 10070	ADAPT ^{MAX} 10105	ADAPT ^{MAX} 10140
ELECTRICAL DATA*					
ELECTRICAL DATA					
Rated voltage	v/Hz	3N~ 400; 50	3N~ 400; 50	3N~ 400; 50	3N~ 400; 50
Max. operation current	A	24,9	49,8	74,7	99,6
Max. electrical power	kW	16,4	32,8	49,2	56,6
Fuses	A	3 x 25	3 x 50	3 x 80	3 x 100
Electrical power cable***	mm²	5 x 6 (H05VV-F)	5 x 16 (Copper)	5 x 25 (Copper)	5 x 35 (Copper)
COMMUNICATION					
Connection between outdoor and indoor unit		FTP 5e cable / 2x2x0,6 mm ² (LiYCY)	2x FTP 5e cable / 2x2x0,6 mm ² (LiYCY)	3x FTP 5e cable / 2x2x0,6 mm ² (LiYCY)	4x FTP 5e kabel / 2x2x0,6 mm ² (LiYCY)
COOLING SYSTEM					
Refrigerant - type		R290	R290	R290	R290
Refrigerant - industrial designation		HC-290 (R290)	HC-290 (R290)	HC-290 (R290)	HC-290 (R290)
GWP (global warming potential) refrigerants		0,02	2x 0,02	3x 0,02	4x 0,02
Total CO ₂ equivalent of charged refrigerant		0,075	2 x 0,075	3 x 0,075	4 x 0,075
Refrigerant - quantity	kg	3,75	2 x 3,75	3 x 3,75	4 x 3,75
Max. refrigerant system operating pressure	MPa	3,2	3,2	3,2	3,2
PRIMARY SIDE (HEAT SOURCE) – AIR					
Air flow	m³/h	up to 12.000	up to 24.000	up to 36.000	up to 48.000
SECONDARY SIDE (HEAT SINK) – WATER					
BUILT-IN CIRCULATION PUMP					
Rated flow at maximum heating capacity and ΔT 5K according to standard EN 14511	m³/h	6,1	12,2	18,3	24,4
Max. available external pressure drop at nominal water flow	kPa	60	50	50	50
HEATING					
Operating envelope - min. / max. air temperature	°C	-25 / 40	-25 / 40	-25 / 40	-25 / 40
Operating envelope - min. / max. water temperature	°C	15 / 75	15 / 75	15 / 75	15 / 75
COOLING					
Operating envelope - min. / max. air temperature	°C	-10 / 45	-10 / 45	-10 / 45	-10 / 45
Operating envelope - min. / max. water temperature	°C	7 / 25	7 / 25	7 / 25	7 / 25
DIMENSIONS AND MASS - TRANSPORT					
Dimensions (W x H x D)	mm	1670 X 1750 X 1100	3665 X 1820 X 1150	5290 X 1820 X 1150	6915 X 1820 X 1150
Mass	kg	520	1180	1745	2232
DIMENSIONS AND MASS - NET					
Dimensions (W x H x D)	mm	1575 x 1575 x 960	3375 x 1683 x 960	5000 x 1683 x 960	6625 x 1683 x 960
Mass	kg	482	1102	1630	2080

* For the system's connection power, power cables, and fuse dimensions, see the instructions on preparing for installation.

** Installation method C, table A.52.4 of IEC 60364-5-52

TECHNICAL DATA - INDOOR UNIT

DEVICE		WR KSM 2	WR KSM+	WR KSM C
ELECTRICAL DATA *				
Rated voltage; Frequency	V/Hz	~ 230; 50	~ 230; 50	~ 230; 50
Max. operating current	A	2,2	2,2	2,2
Max. electric power	kW	0,5	0,5	0,5
Fuses	A	1 x C10	1 x C10	1 x C10
Power cable	mm ²	3 x 1,5	3 x 1,5	3 x 1,5
Type of power cable		H05VV-F	H05VV-F	H05VV-F

*For system Max. power, power cables and fuse dimensions, see Installation guidelines

DIMENSIONS AND WEIGHT - TRANSPORT

Dimensions (W x H x D)	mm ²	420 X 370 X 120	220 X 370 X 120	220 X 370 X 120
Weight	kg	5	2,5	2,8

DIMENSIONS AND WEIGHT - NET

Dimensions (W x H x D)	mm ²	400 X 350 X 90	200 X 350 X 90	200 X 350 X 90
Weight	kg	4,3	2,3	2,6

COMMUNICATION

Connection between heat pump and wall controller		FTP 5e cable / 2x2x0,6 mm2 (LiVCY)	FTP 5e cable / 2x2x0,6 mm2 (LiVCY)	FTP 5e cable / 2x2x0,6 mm2 (LiVCY)
Connection to BMS		MODBUS protocol (UTP cable connection RJ45) - RS485	MODBUS protocol (UTP cable connection RJ45) - RS485	MODBUS protocol (UTP cable connection RJ45) - RS485
Connection to the internet		UTP cable - connection RJ45 - Ethernet	UTP cable - connection RJ45 - Ethernet	UTP cable - connection RJ45 - Ethernet

DEVICE		WR KSM MAX 10070	WR KSM MAX 10105	WR KSM MAX 10140
ELECTRICAL DATA *				
Electrical data	V/Hz	~230; 50	~230; 50	~230; 50
Max. operating current	A	2,2	2,2	2,2
Max electric power	kW	0,5	0,5	0,5
Fuses	A	1 x C10	1 x C10	1 x C10
Power cable	mm ²	3 x 1,5	3 x 1,5	3 x 1,5
Type of power cable		H05VV-F	H05VV-F	H05VV-F

*For system Max. power, power cables and fuse dimensions, see installation guidelines.

DIMENSIONS AND WEIGHT - TRANSPORT

Dimensions (W x H x D)	mm	600 x 700 x 120	600 x 700 x 120	600 x 700 x 120
Weight	kg	9	10,3	11,5

DIMENSIONS AND WEIGHT - NET

Dimensions (W x H x D)	mm	400 x 685 x 90	400 x 685 x 90	400 x 685 x 90
Weight	kg	7	8,3	9,5

COMMUNICATION

Connection between heat pump and wall controller		2 x FTP 5e cable / 2x2x0,6 mm2 (LiVCY)	3 x FTP 5e cable / 2x2x0,6 mm2 (LiVCY)	4 x FTP 5e cable / 2x2x0,6 mm2 (LiVCY)
Connection to BMS		MODBUS protocol (UTP cable connection RJ45) - RS485	MODBUS protocol (UTP cable connection RJ45) - RS485	MODBUS protocol (UTP cable connection RJ45) - RS485
Connection to the internet		UTP cable - connection RJ45 - ETHERNET	UTP cable - connection RJ45 - ETHERNET	UTP cable - connection RJ45 - ETHERNET

SOUND

Description

- Sound power is a characteristic of a sound source and is not related to distance; describes the total sound energy of an appropriate source that is emitted in all directions.
- Sound pressure depends on the measurement site in the sound field and describes the sound pressure at that location.
- When sound is transmitted through the structure, it is necessary to equip the connection with absorbers or compensators in order to prevent the transmission of unwanted structural sound.

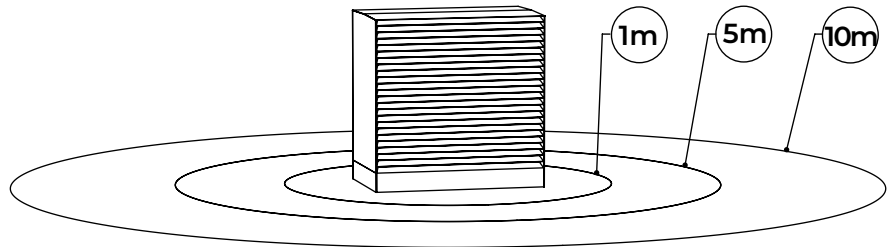

DEVICE	Unit	ADAPT ^{MAX} 10035	ADAPT ^{MAX} 10070	ADAPT ^{MAX} 10105	ADAPT ^{MAX} 10140
SOUND ACCORDING TO EN 12102 AT THE CONDITION OF A7W35					
THE DECLARED SOUND POWER ON THE ECOLABEL ENERGY LABEL					
Sound power (A7W35)	dB (A)	49	52	54	55
Sound pressure level at the distance of 1 m	dB (A)	41	44	46	47
Sound pressure level at the distance of 5 m	dB (A)	27	30	32	33
Sound pressure level at the distance of 10 m	dB (A)	21	24	26	27
SOUND POWER AT STANADRD RATED CONDITION (A7W35)					
Sound power	dB (A)	68	71	73	74
Sound pressure level at the distance of 1 m	dB (A)	60	63	65	66
Sound pressure level at the distance of 5 m	dB (A)	46	49	51	52
Sound pressure level at the distance of 10 m	dB (A)	40	43	45	46
MAXIMUM SOUND POWER (A7W35)					
Sound power	dB (A)	72	75	77	78
Sound pressure level at the distance of 1 m	dB (A)	64	67	69	70
Sound pressure level at the distance of 5 m	dB (A)	50	53	55	56
Sound pressure level at the distance of 10 m	dB (A)	44	47	49	50
MINIMUM SOUND POWER (A7W35)					
Sound power	dB (A)	49	52	53	55
Sound pressure level at the distance of 1 m	dB (A)	41	44	46	47
Sound pressure level at the distance of 5 m	dB (A)	27	30	32	33
Sound pressure level at the distance of 10 m	dB (A)	21	24	26	27
MAXIMUM SOUND POWER IN SILENT MODE (A7W35)					
Sound power	dB (A)	61	64	66	67
Sound pressure level at the distance of 1 m	dB (A)	53	56	58	59
Sound pressure level at the distance of 5 m	dB (A)	39	42	44	45
Sound pressure level at the distance of 10 m	dB (A)	33	36	38	39
SOUND POWER AT STANADRD RATED CONDITION A2W35 (EN14825, PART LOAD)					
Sound power	dB (A)	59	62	64	65
Sound pressure level at the distance of 1 m	dB (A)	51	54	56	57
Sound pressure level at the distance of 5 m	dB (A)	37	40	42	43
Sound pressure level at the distance of 10 m	dB (A)	31	34	36	37

The device's sound power depends on the building's actual heating needs. The lower the heating needs, the lower the noise levels, and vice versa. Sound pressure is calculated from the sound power at the hemispherical layout ($Q = 2$).

Tonality:

No tonal sounds or frequencies throughout the entire operating range.

Measurement Uncertainty:

The sound power level was determined according to ISO 9614-2. The standard deviation of the sound power level is 1.5 dB. At a confidence level of 95%, the actual A-weighted sound power level falls within the range of ± 3 dB around the measured values.

ADAPT^{MAX} 10035

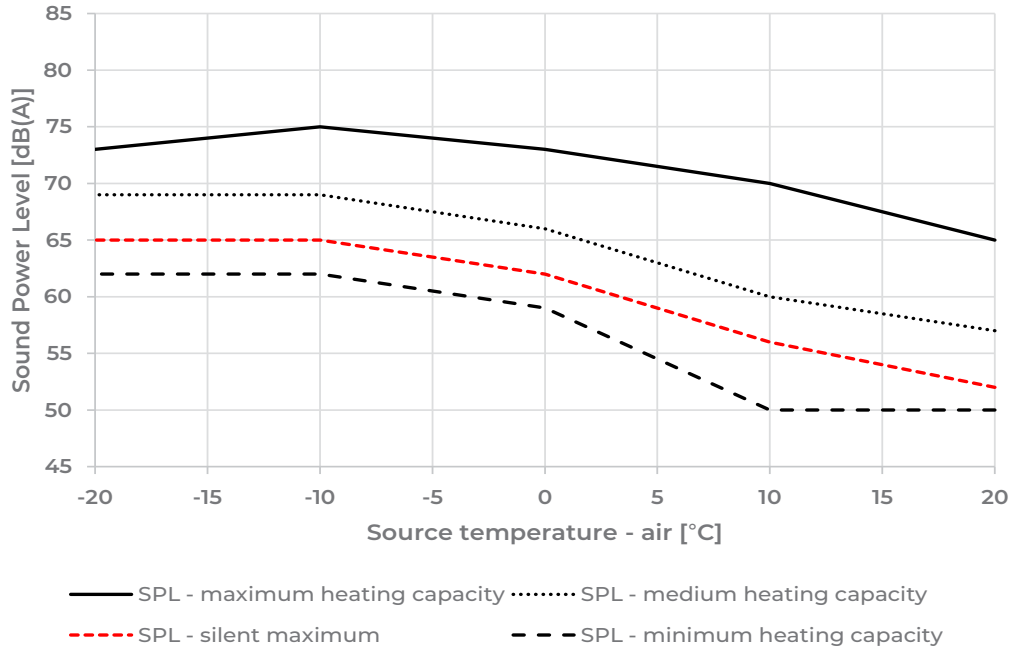

ADAPT^{MAX} 10070

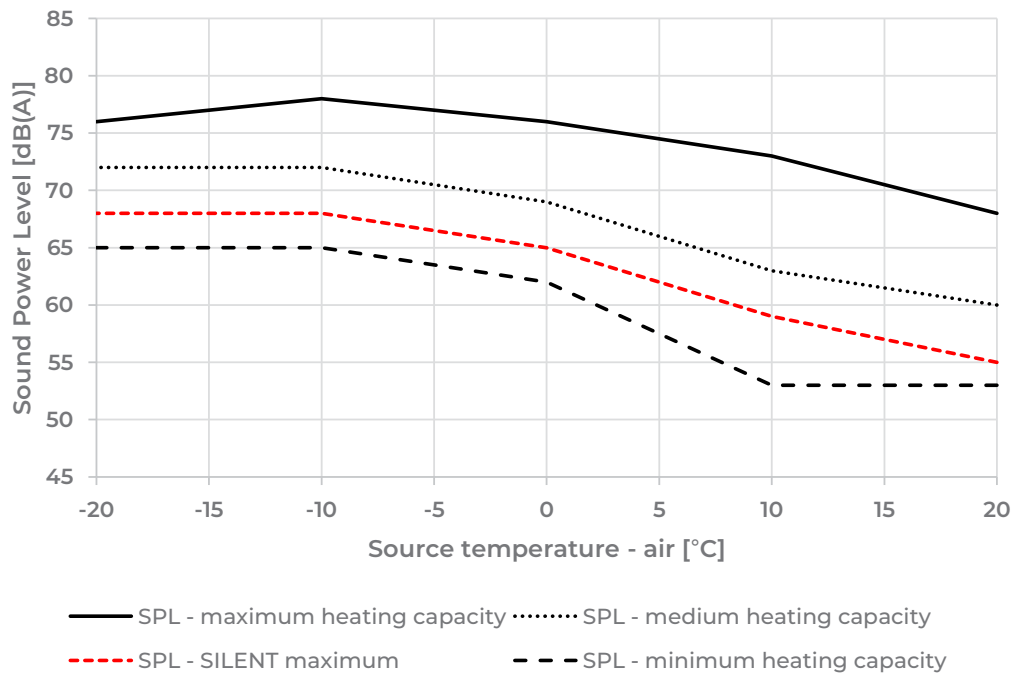

ADAPT^{MAX} 10105

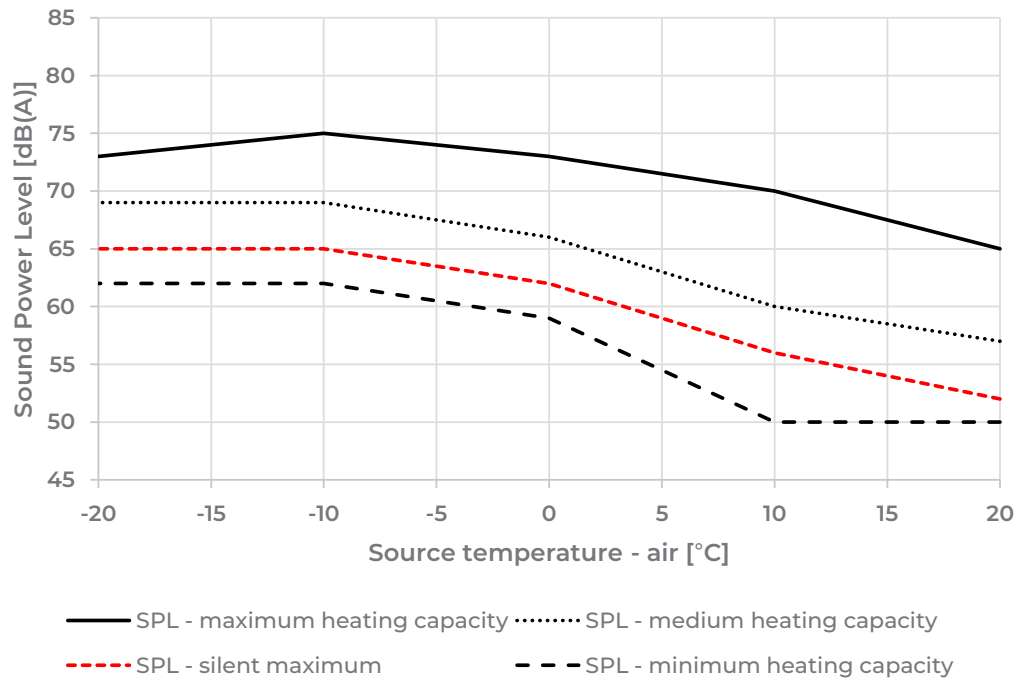

ADAPT^{MAX} 10140

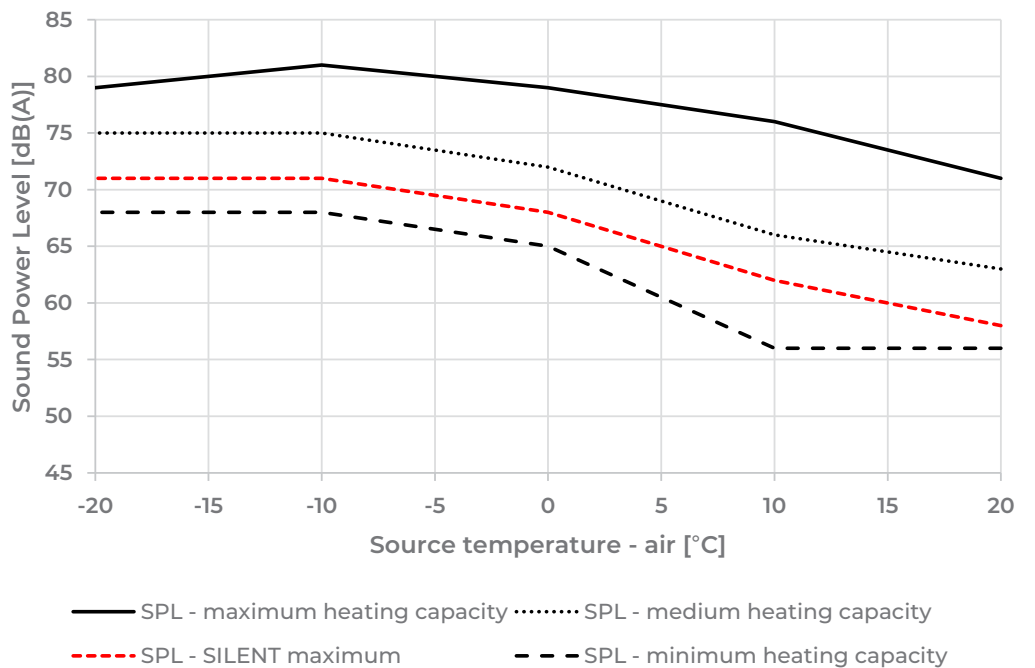

OPERATING ENVELOPE

Heating

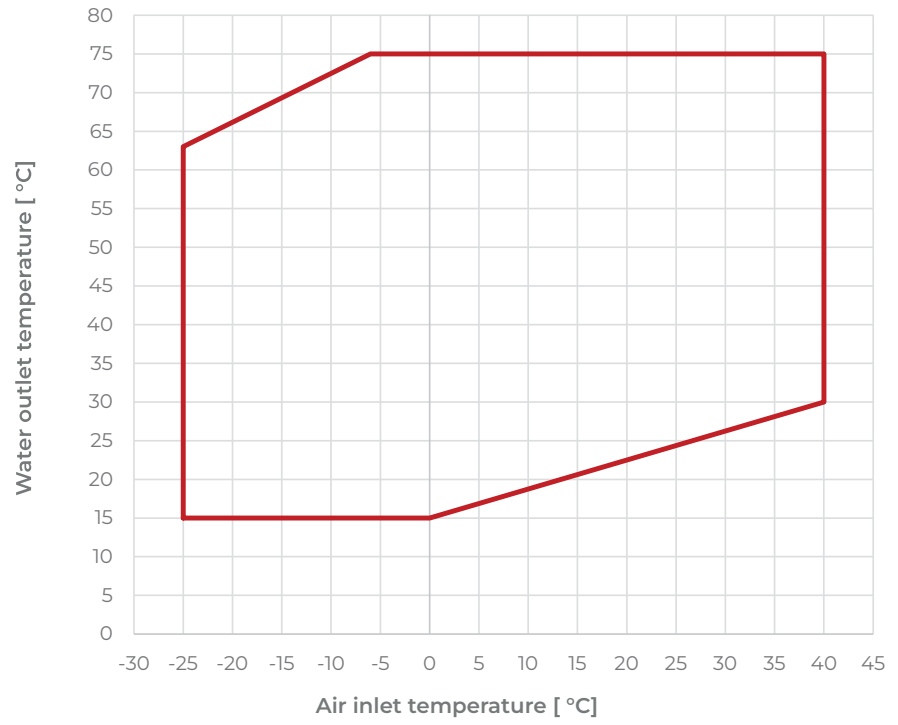

Cooling

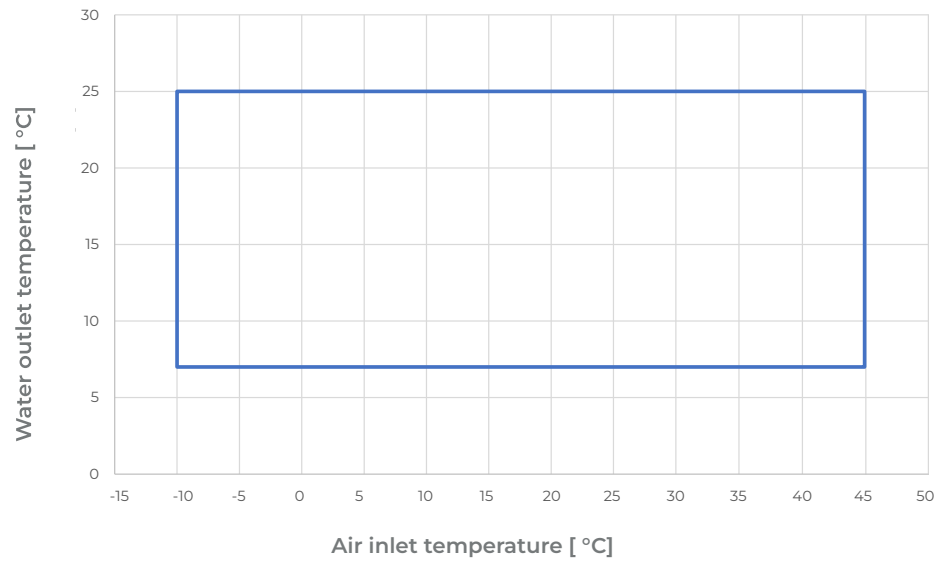

CAPACITY CURVES

ADAPT^{MAX} 10035
Heating capacity

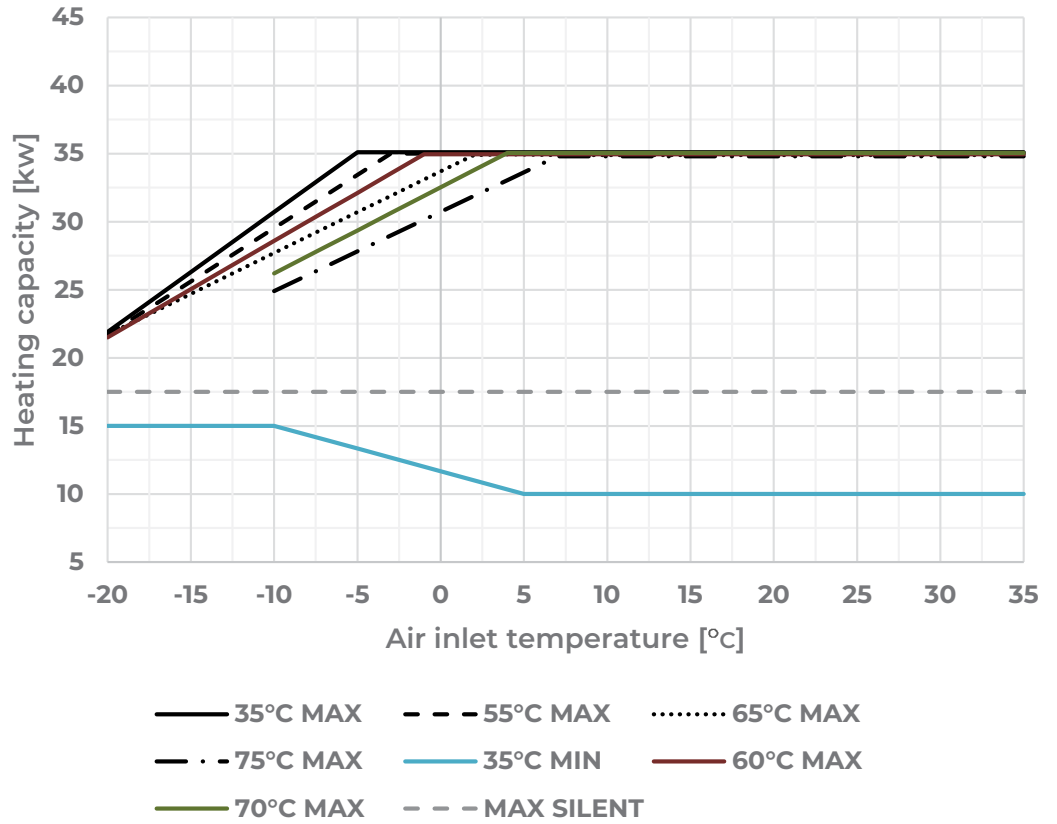

ADAPT^{MAX} 10035
Cooling capacity

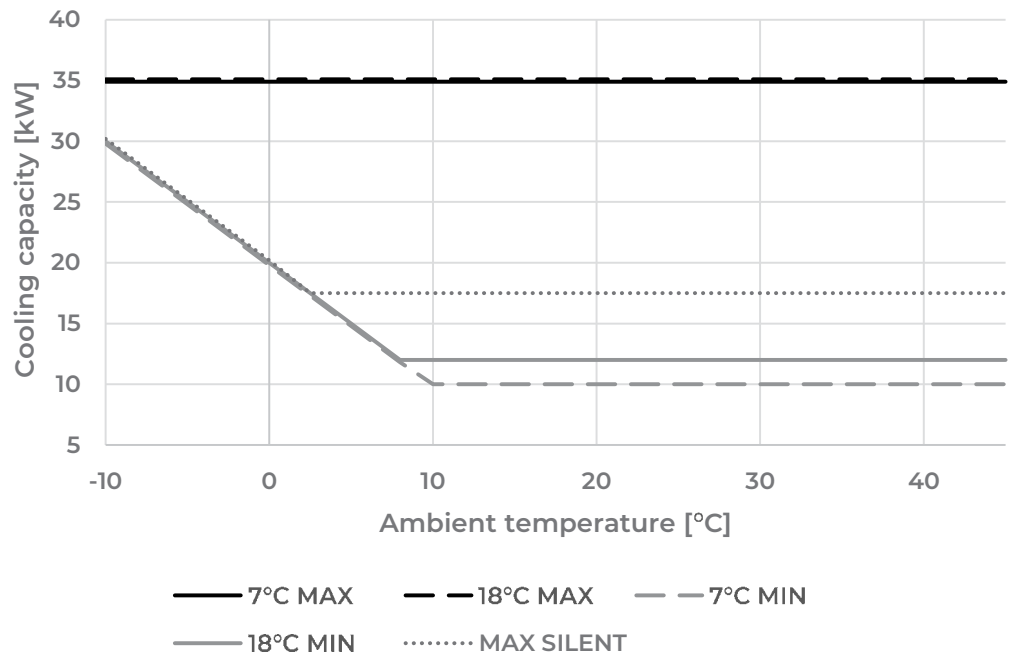

The maximum heat power of the heat pump depends on selected operation mode.

BOOST: in this mode the heat pump has a higher maximum capacity, high levels of noise, and low efficiency.

OPTIMAL: in this mode the heat pump has the highest level of efficiency and the best ratio between heating capacity and noise levels.

SILENT: in this mode the heat pump has low noise level, a lower maximum heating capacity, and low efficiency.

ADAPT^{MAX} 10070
Heating capacity

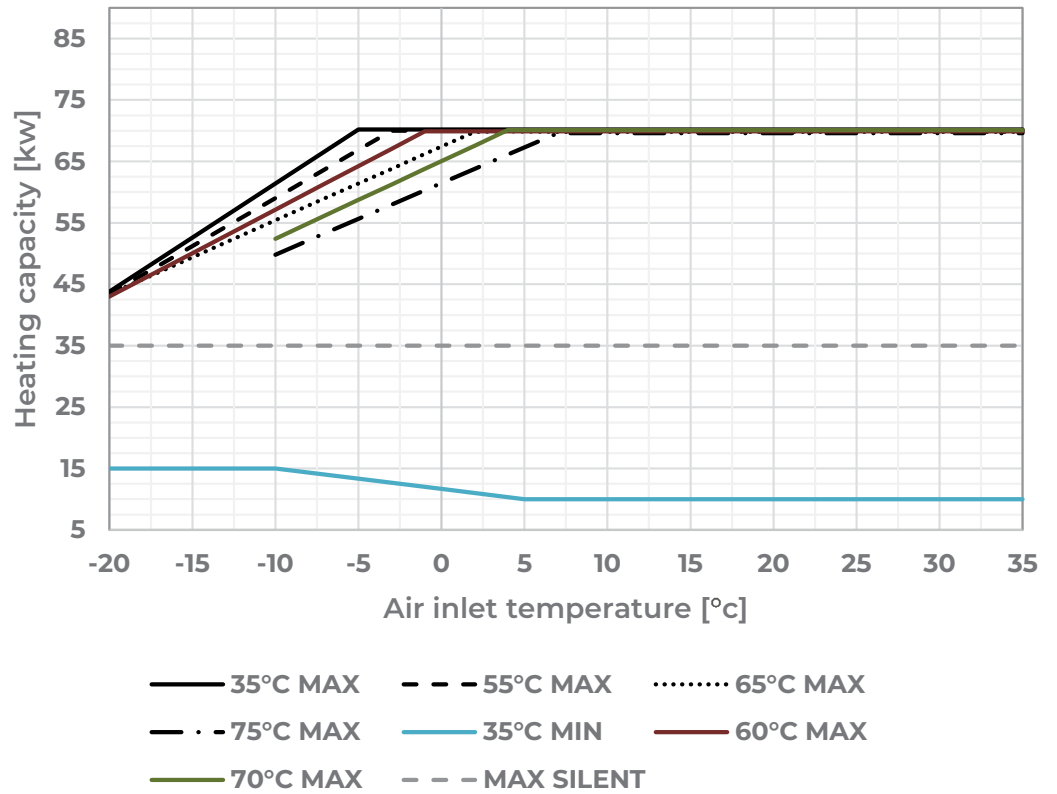

ADAPT^{MAX} 10070
Cooling capacity

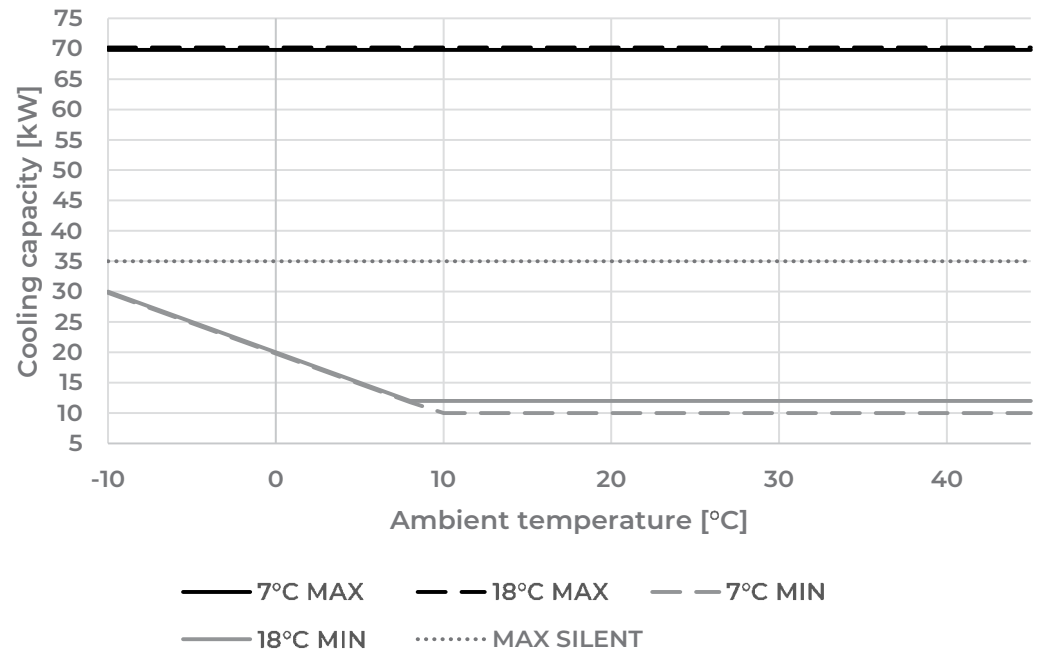

The maximum heat power of the heat pump depends on selected operation mode.

BOOST: in this mode the heat pump has a higher maximum capacity, high levels of noise, and low efficiency.

OPTIMAL: in this mode the heat pump has the highest level of efficiency and the best ratio between heating capacity and noise levels.

SILENT: in this mode the heat pump has low noise level, a lower maximum heating capacity, and low efficiency.

ADAPT^{MAX} 10105
Heating capacity

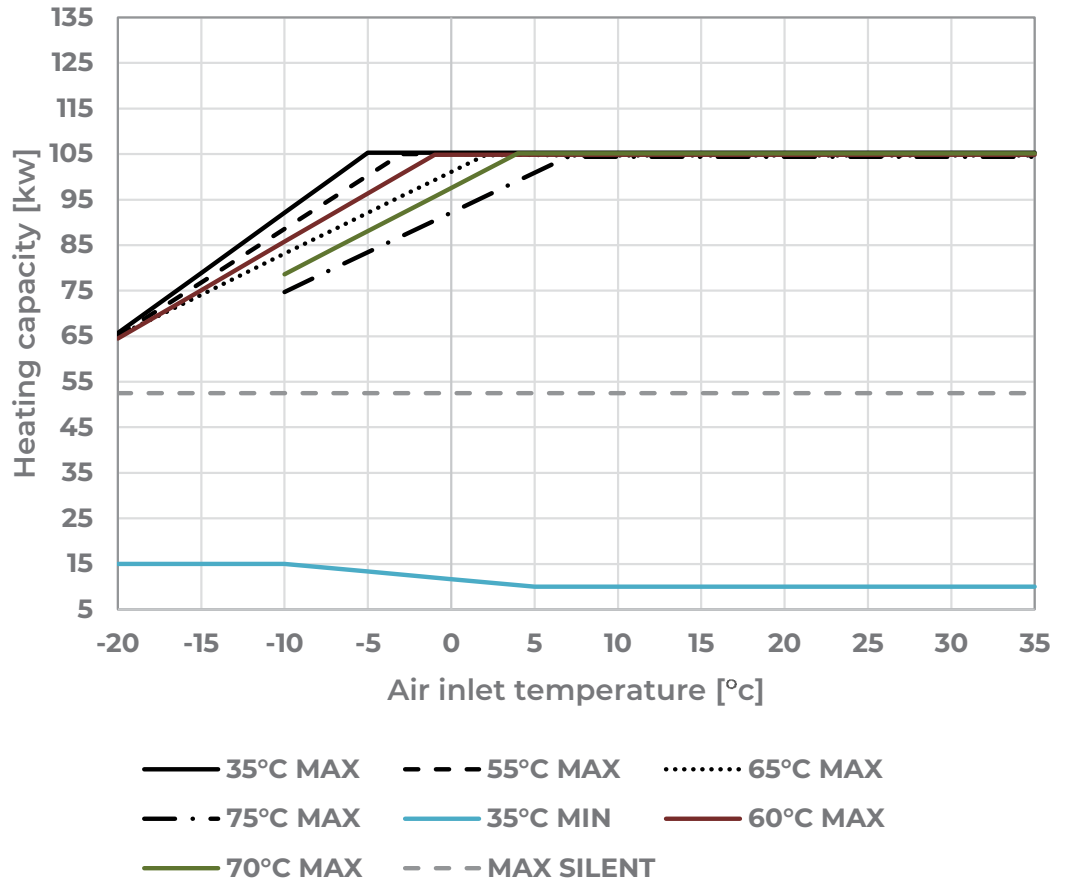

ADAPT^{MAX} 10105
Cooling capacity

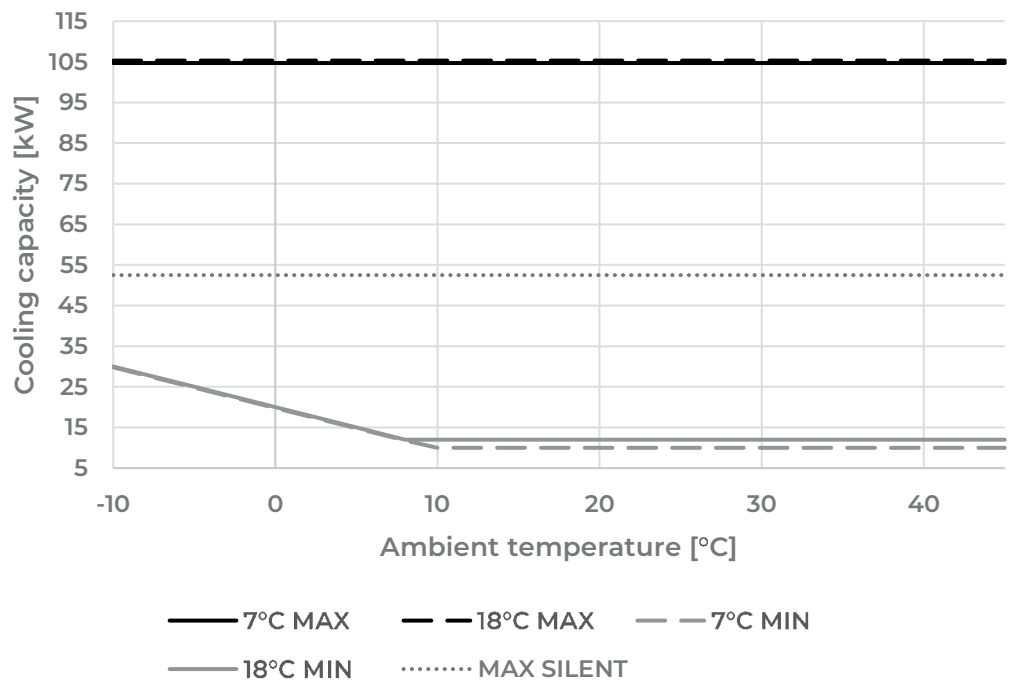

The maximum heat power of the heat pump depends on selected operation mode.

BOOST: in this mode the heat pump has a higher maximum capacity, high levels of noise, and low efficiency.

OPTIMAL: in this mode the heat pump has the highest level of efficiency and the best ratio between heating capacity and noise levels.

SILENT: in this mode the heat pump has low noise level, a lower maximum heating capacity, and low efficiency.

ADAPT^{MAX} 10140
Heating capacity

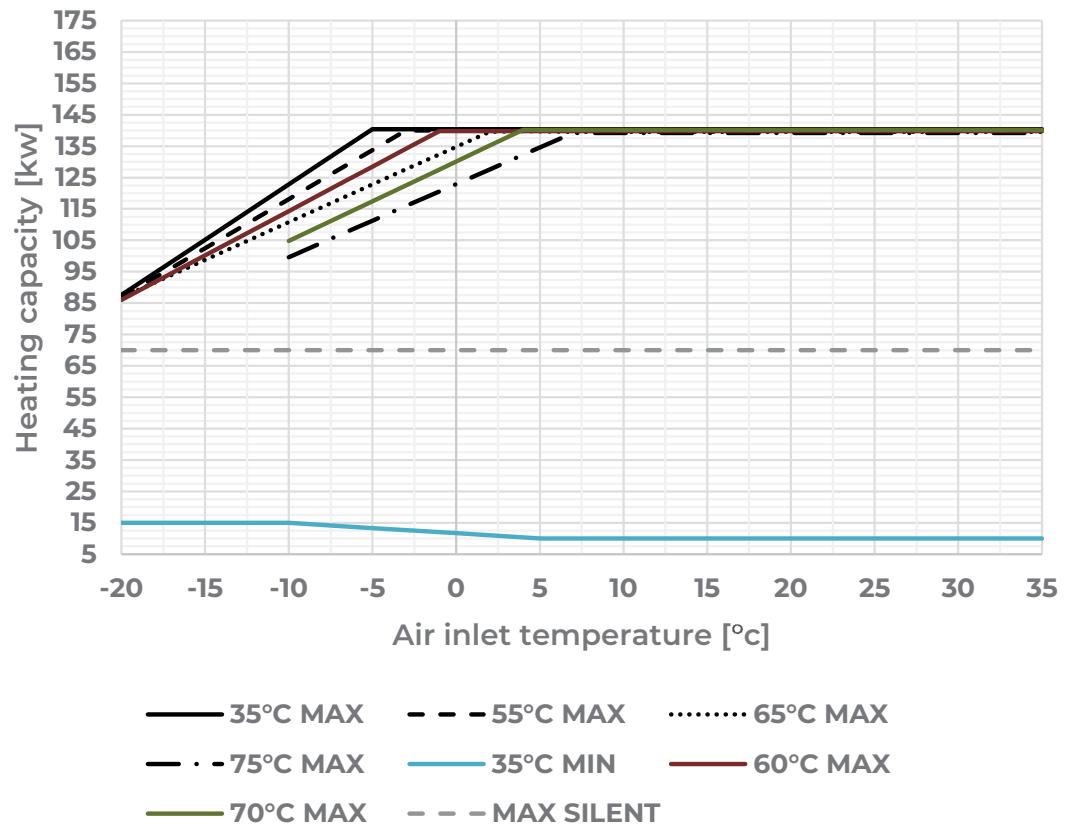

ADAPT^{MAX} 10140
Cooling capacity

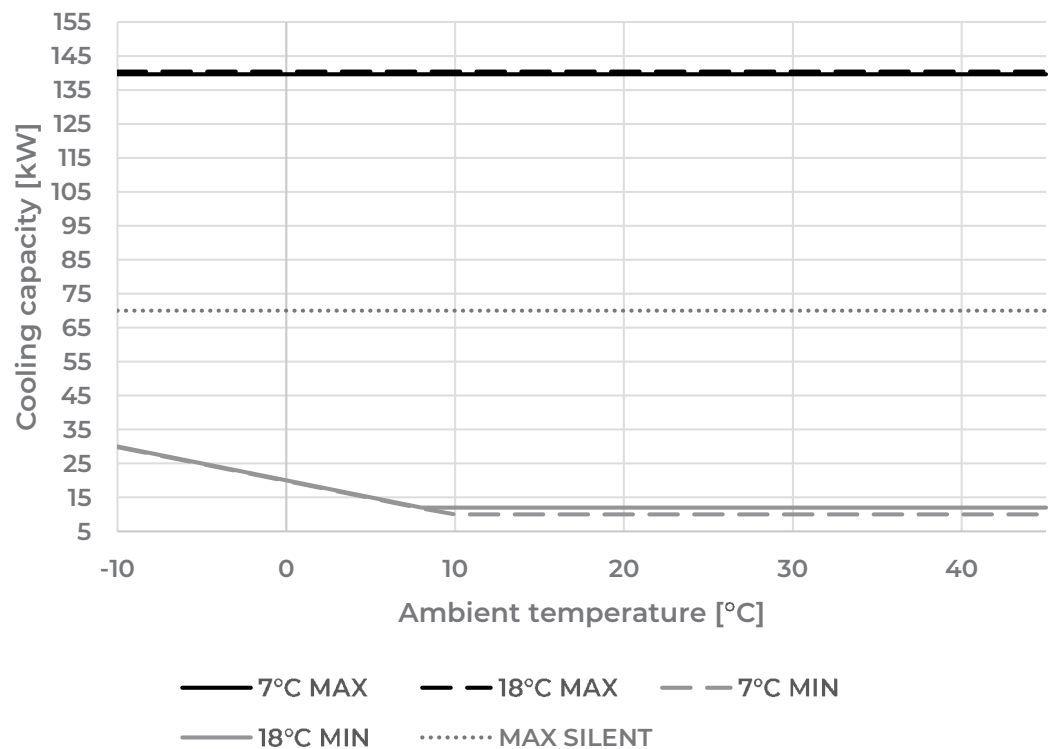

The maximum heat power of the heat pump depends on selected operation mode.

BOOST: in this mode the heat pump has a higher maximum capacity, high levels of noise, and low efficiency.

OPTIMAL: in this mode the heat pump has the highest level of efficiency and the best ratio between heating capacity and noise levels.

SILENT: in this mode the heat pump has low noise level, a lower maximum heating capacity, and low efficiency.

BASIC INSTALLATION DIAGRAM

ADAPT^{MAX} heating and domestic hot water

ADAPT MAX 10035 + WR KSM 2

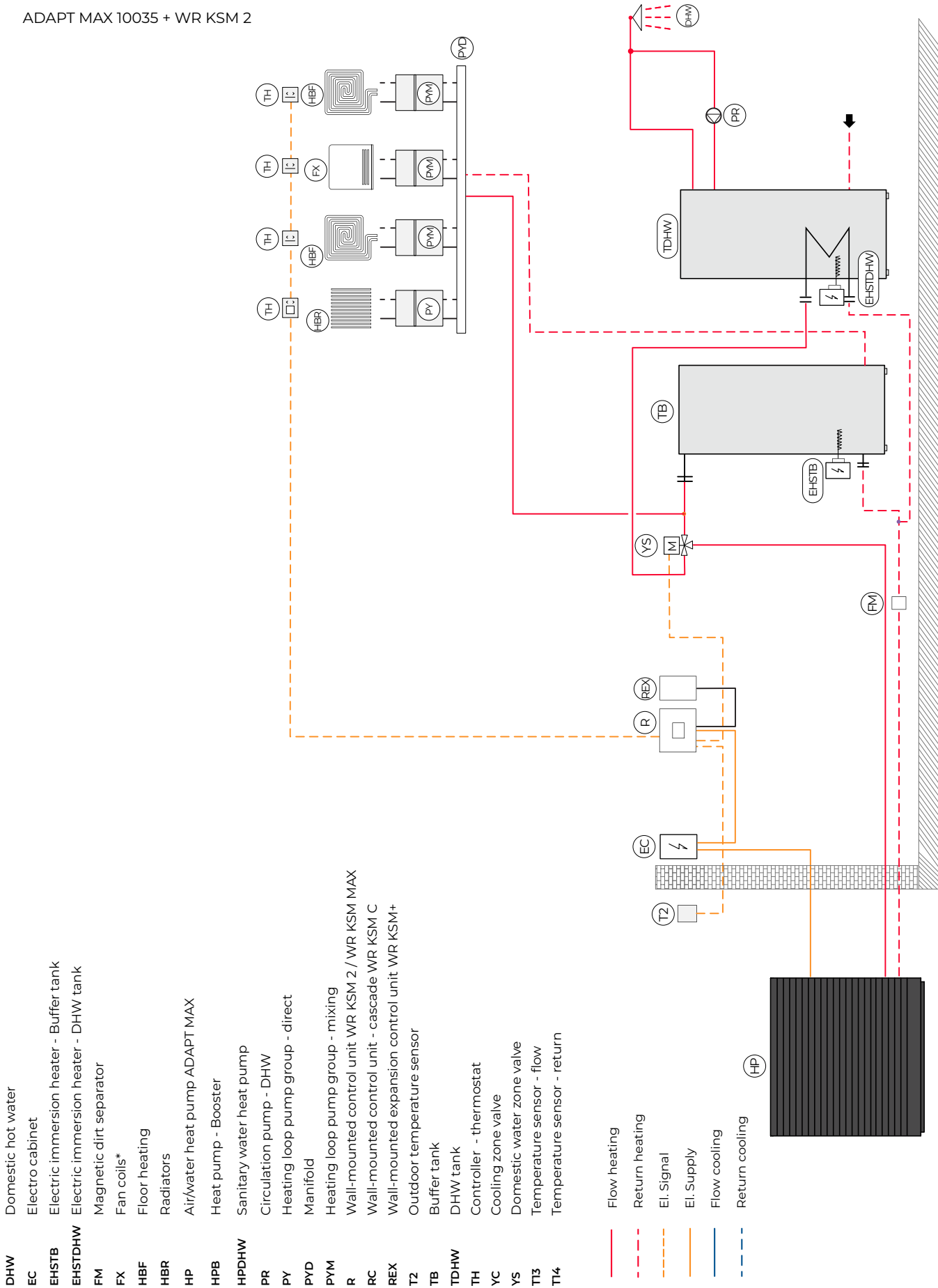

An informative set of items from the KRONOTERM sales program is shown. For proper system planning, use the KRONOTERM SOLUTIONS app on the KRONOTERM partner portal.
*When using convectors for cooling, please refer to "Preparing for installation" instructions for the ADAPT^{MAX} system.

BASIC INSTALLATION DIAGRAM

ADAPT^{MAX} heating, cooling and domestic hot water

ADAPT MAX 10035 + WR KSM 2 + WR KSM+

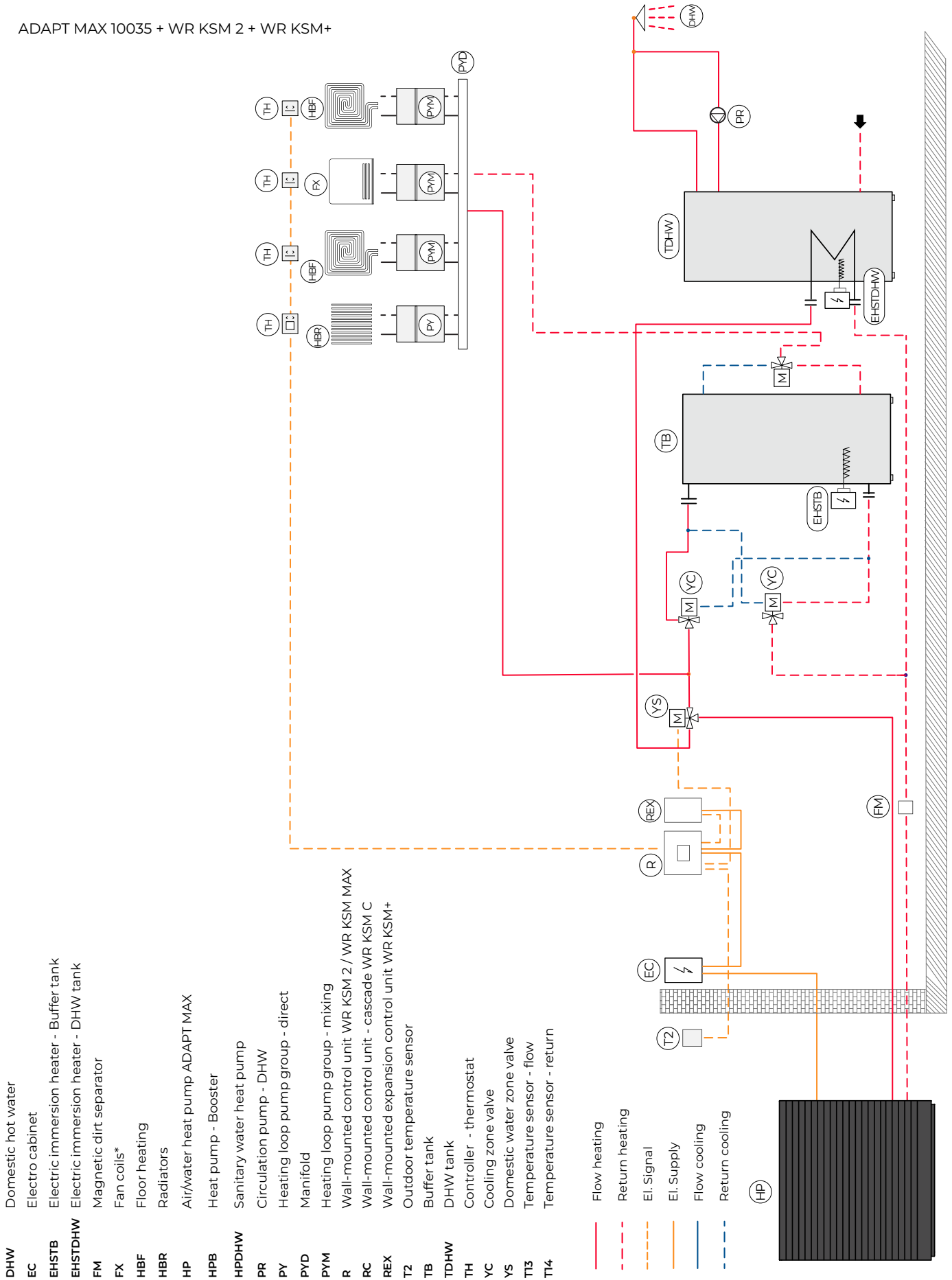

An informative set of items from the KRONOTERM sales program is shown. For proper system planning, use the KRONOTERM SOLUTIONS app on the KRONOTERM partner portal.
*When using convectors for cooling, please refer to "Preparing for installation" instructions for the ADAPT^{MAX} system.

BASIC INSTALLATION DIAGRAM

ADAPT^{MAX} heating and domestic hot water heat pump

ADAPT^{MAX} 10(070/105/140) + WR KSM 2 + WR KSM+ + WR KSM C

- DHW Domestic hot water
- EC Electro cabinet
- EHSTB Electric immersion heater - Buffer tank
- EHSTDHW Electric immersion heater - DHW tank
- FM Magnetic dirt separator
- FX Fan coils*
- HBF Floor heating
- HBR Radiators
- HP Air/water heat pump ADAPT MAX
- HPB Heat pump - Booster
- HPDHW Sanitary water heat pump
- PR Circulation pump - DHW
- PY Heating loop pump group - direct
- PYD Manifold
- PYM Heating loop pump group - mixing
- R Wall-mounted control unit WR KSM 2 / WR KSM MAX
- RC Wall-mounted control unit - cascade WR KSM C
- REX Wall-mounted expansion control unit WR KSM+
- T2 Outdoor temperature sensor
- TB Buffer tank
- TDHW DHW tank
- TH Controller - thermostat
- YC Cooling zone valve
- Y5 Domestic water zone valve
- TI3 Temperature sensor - flow
- TI4 Temperature sensor - return

- Flow heating
- - - Return heating
- · - · - El. Signal
- El. Supply
- Flow cooling
- · - · - Return cooling

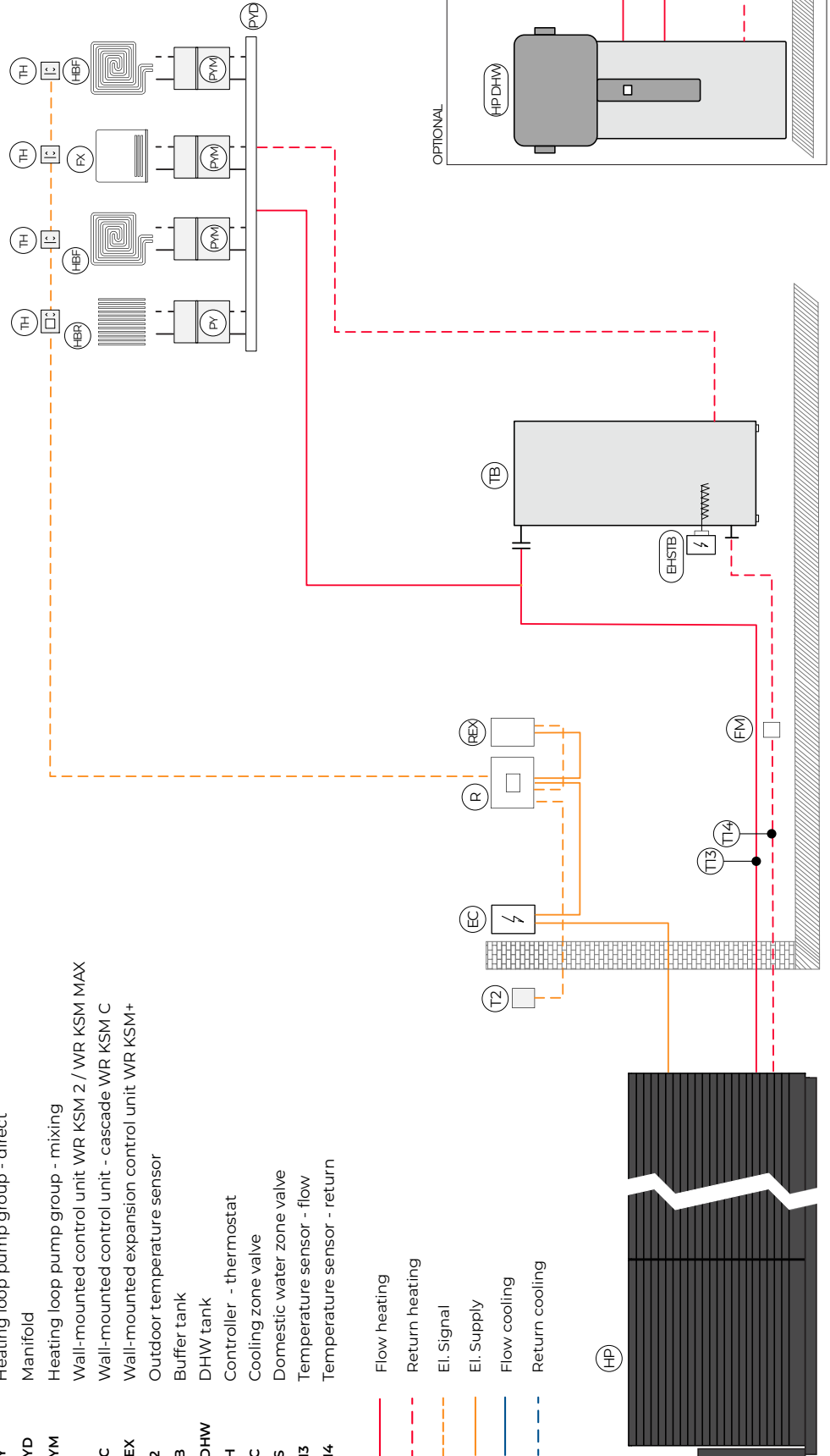

An informative set of items from the KRONOTERM sales program is shown. For proper system planning, use the KRONOTERM SOLUTIONS app on the KRONOTERM partner portal.
*When using convectors for cooling, please refer to "Preparing for installation" instructions for the ADAPT^{MAX} system.

BASIC INSTALLATION DIAGRAM

ADAPT^{MAX} heating, cooling and domestic hot water heat pump

ADAPT^{MAX} 10035 + WR KSM 2 + WR KSM C

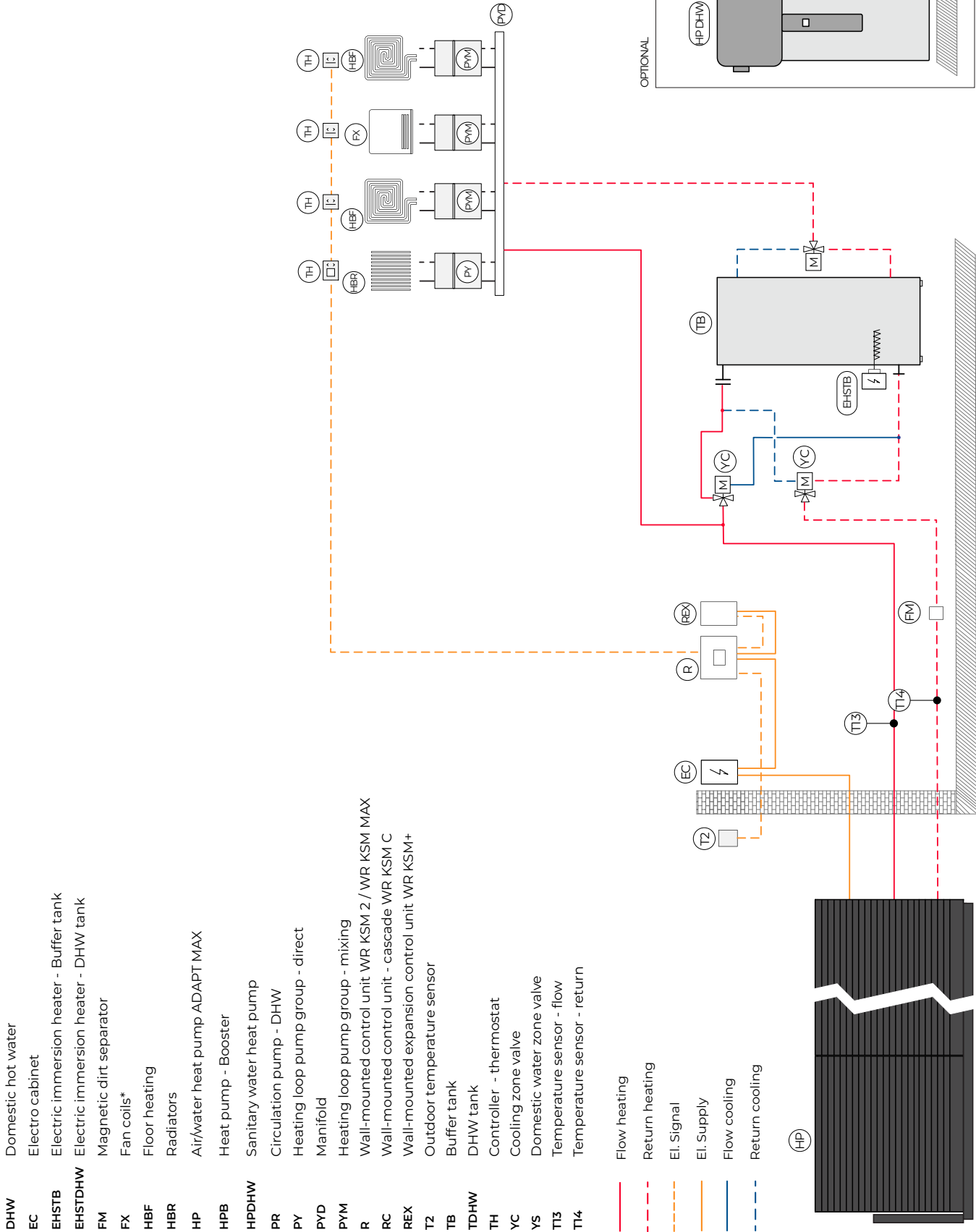

An informative set of items from the KRONOTERM sales program is shown. For proper system planning, use the KRONOTERM SOLUTIONS app on the KRONOTERM partner portal.
 *When using convectors for cooling, please refer to "Preparing for installation" instructions for the ADAPT^{MAX} system.

BASIC INSTALLATION DIAGRAM

ADAPT^{MAX} heating, cooling and domestic hot water with booster

ADAPT^{MAX} 10035 + WR KSM 2 + WR KSM C

- DHW Domestic hot water
- EC Electro cabinet
- EHSTB Electric immersion heater - Buffer tank
- EHSTDHW Electric immersion heater - DHW tank
- FM Magnetic dirt separator
- FX Fan coils*
- HBF Floor heating
- HBR Radiators
- HP Air/water heat pump ADAPT MAX
- HPB Heat pump - Booster
- HPDHW Sanitary water heat pump
- PR Circulation pump - DHW
- PY Heating loop pump group - direct
- PYD Manifold
- PYM Heating loop pump group - mixing
- R Wall-mounted control unit WR KSM 2 / WR KSM MAX
- RC Wall-mounted control unit - cascade WR KSM C
- REX Wall-mounted expansion control unit WR KSM+
- T2 Outdoor temperature sensor
- TB Buffer tank
- TDHW DHW tank
- TH Controller - thermostat
- YC Cooling zone valve
- YS Domestic water zone valve
- TT3 Temperature sensor - flow
- TT4 Temperature sensor - return

- Flow/heating
- - - Return heating
- - - EI. Signal
- EI. Supply
- Flow cooling
- - - Return cooling

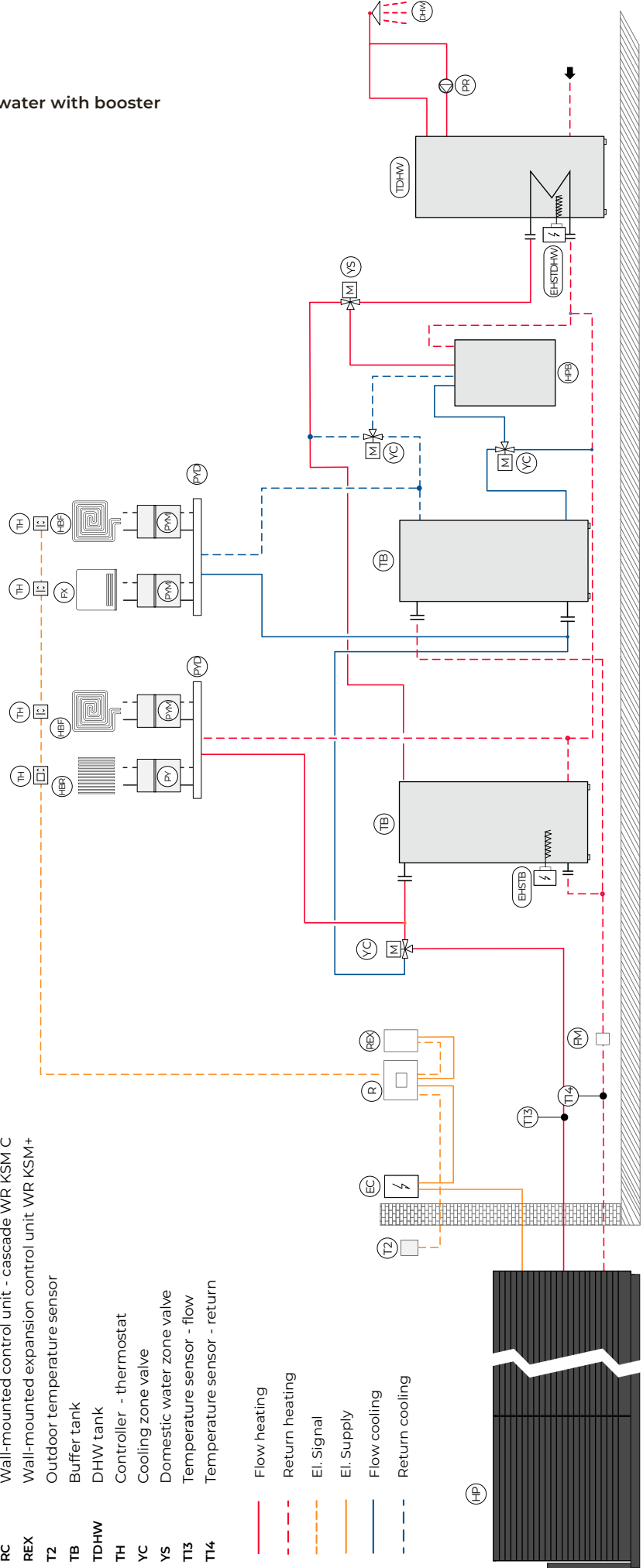

An informative set of items from the KRONOTERM sales program is shown. For proper system planning, use the KRONOTERM SOLUTIONS app on the KRONOTERM partner portal.
*When using convectors for cooling, please refer to "Preparing for installation" instructions for the ADAPT^{MAX} system.

KRONOTERM d.o.o.

Trnava 5e, 3303 Gomilsko, SLO

T +386 3 703 16 20

www.kronoterm.com

info@kronoterm.com